

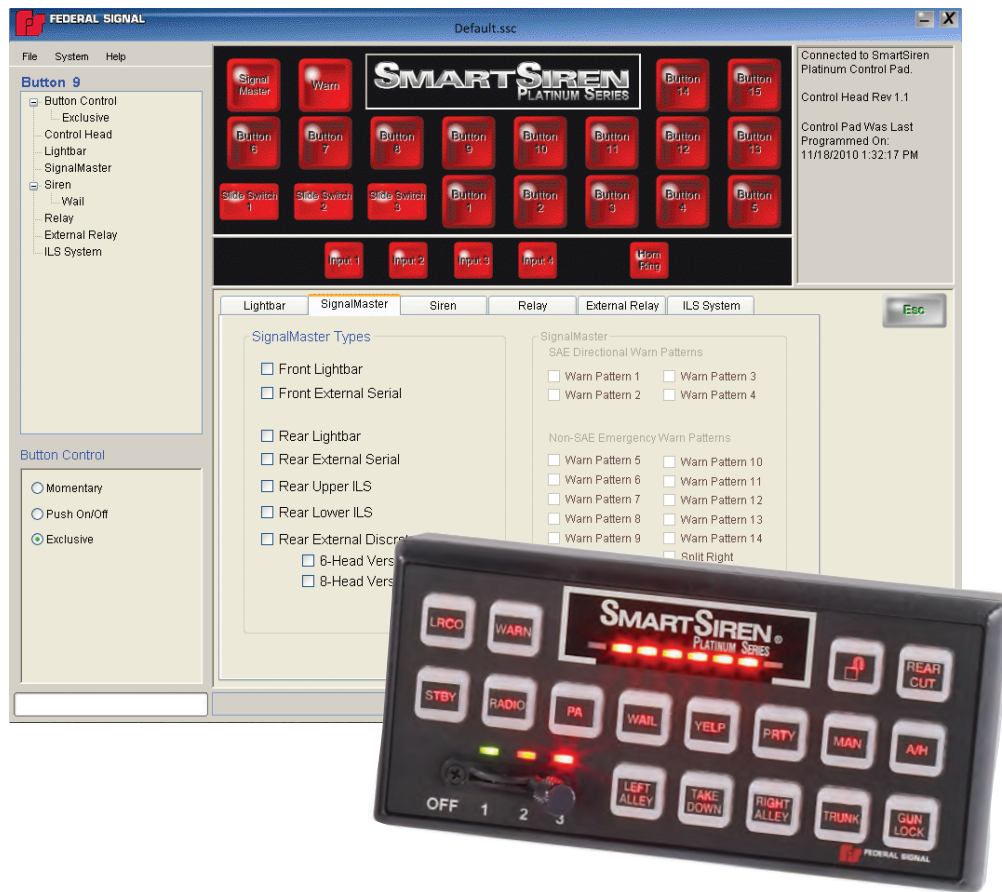

FEDERAL SIGNAL
Public Safety Systems

SMART SIREN[®] PLATINUM SERIES



Control Pad Configuration Software Manual

Arjent®, Legend®, Raydian®, SmartSiren®, Solaris®, Impaxx®, and Viper® are registered trademarks of Federal Signal Corp.

Convergence is a trademark of Federal Signal Corporation.

Pentium® is a registered trademark of Intel Corporation.

Windows® is a registered trademark of Microsoft Corporation in the United States and other countries.

InstallShield is a registered trademark and/or service mark of InstallShield Corporation.

Table of Contents

CHAPTER 1 Safety Messages	7
Safety Messages to Users of This Software	7
Safety Messages to Installers of Federal Signal Electronic Sirens and Sound/Light Systems	7
CHAPTER 2 Preparing to Program the Control Pad	10
System Requirements	10
Installing the Software	11
Connecting the Control Pad to Your Computer in Windows XP	12
Connecting the Control Pad to Your Computer in Windows Vista/7	16
CHAPTER 3 Exploring the Interface	21
An Overview of the SmartSiren Platinum Configuration Software	21
Application Header	23
Minimize Window (-) Button and Close Program (X) Buttons	23
Connection Status Pane	23
The Four Programming Modules	24
The Button Configuration Module	24
The Button Selection Module	25
SignalMaster and Warn Buttons	25
Slide Switch Buttons	26
The Device Selection Module	26
Device Selection Tabs	27
Option Buttons and Checkboxes	27
Drop-Down Lists	27
Escape Button	28
The Button Control Module	28
Inputs 1 to 4	29
Horn Ring	30
File Transfer Status Panes	30
Uploading Configuration Files	30
Downloading Configuration Files	30
CHAPTER 4 Configuring the Lightbar	34
An Overview of the Lightbar Pane	34
Lightbar Default Settings	35
Assigning Lightbar Functions to Buttons	35
Linking Buttons to Slide Switch Positions (Lightbar Pane)	39
CHAPTER 5 Configuring the SignalMaster	44
An Overview of the SignalMaster Pane	44
SignalMaster Default Settings	45
Assigning SignalMaster Control to the SignalMaster Button	46

Assigning SignalMaster Control to the Warn Button	48
Assigning SignalMaster Control to Buttons 1 to 15 and Inputs	51
Assigning SignalMaster Control to the Slide Switch	54
CHAPTER 6 Configuring the Siren.....	59
An Overview of the Siren Pane	59
Siren Default Settings.....	60
Siren Functions for Buttons 1–15	60
Siren Functions for Slide Switch 1–3	63
Siren Input Control for Inputs 1–4.....	66
CHAPTER 7 Configuring the Internal Relays.....	71
An Overview of the Internal Relays	71
Relay Default Settings	72
Configuring the Internal Relays (Buttons 1 to 15 and Inputs)	72
Configuring the Internal Relays for the Slide Switch Buttons	76
CHAPTER 8 Configuring the External Relay	81
An Overview of the External Relay	81
Configuring the External Relay	82
Configuring the External Relay for the Slide Switch Buttons	85
CHAPTER 9 Configuring the ILS System	89
An Overview of the ILS System	89
Configuring the ILS System	90
Configuring the ILS System for the Slide Switch Buttons	93
CHAPTER 10 Completing the Control Pad Configuration	98
Final Steps in Completing the Configuration	98
Saving Your Completed Configuration File.....	98
Printing a Record of Your Configuration File.....	99
Uploading the Configuration File to the Control Pad.....	101
Putting the Control Pad into Operation Mode	101
Testing the SmartSiren Platinum System	102
APPENDIX.....	103
Troubleshooting Your IP Connection in Windows XP.....	103
Resetting the IP Address in Windows XP	105
Troubleshooting Your IP Connection in Windows Vista/7.....	108
Resetting Your IP Address in Windows Vista/7	110
The Default Configuration.....	115
Button Layout Worksheet	116

Tables of Functions

Button Control Capabilities.....	31
Menu Commands.....	32
Lightbar Auxiliary Functions	42
SignalMaster Types	57
SignalMaster ILS Directional Patterns	58
Fast and Low Power Options.....	58
Siren Function (Buttons 1–15).....	69
Siren Control (Buttons 1–15)	69
Siren Control (Horn Ring)	69
Siren Control (Inputs 1–4).....	70
Siren Control (Slide Switch 1–3).....	70
Pins for Internal Solid State Relay.....	79
Switch Positions for Internal Solid State Relays	79
Flash Functions for Perimeter Lights: Internal Relays.....	80
Flash Functions for Perimeter Lights: External Relay	88
ILS System Functions.....	97

CHAPTER 1

Safety Messages

Safety Messages to Users of This Software

⚠ WARNING

People's lives depend on your safe installation and usage of Federal Signal products. It is important to read, understand, and follow all instructions shipped with the products. In addition, listed below are some other important safety instructions and precautions you should follow:

- The SmartSiren® Platinum enables installers to easily change the configuration and functions of the sound and light warning systems of an emergency vehicle. To avoid configuration errors, it is important to carefully read this manual before using this software.

To help you plan your configuration, use the worksheet is on page 116.

Failure to follow all safety precautions and instructions may result in property damage, serious injury, or death to you or others.

Safety Messages to Installers of Federal Signal Electronic Sirens and Sound/Light Systems

⚠ WARNING

People's lives depend on your proper installation and servicing of Federal Signal products. It is important to read and follow all instructions shipped with this product. In addition, listed below are some other important safety instructions and precautions you should follow:

Before Installation

Qualifications

- To properly install an electronic siren you must have a good understanding of automotive electrical procedures and systems, along with proficiency in the installation and service of safety warning equipment. Always refer to the vehicle's service manuals when performing equipment installations on a vehicle.

Sound Hazards

- Your hearing and the hearing of others, in or close to your emergency vehicle, could be damaged by loud sounds. This can occur from short exposures to very loud sounds, or from longer exposures to moderately loud sounds. For hearing conservation guidance, refer to federal, state, or local recommendations. OSHA Standard 1910.95 offers guidance on "Permissible Noise Exposure."

Safety Messages

All effective sirens and horns produce loud sounds (120 dB) that may cause permanent hearing loss. Always minimize your exposure to siren sound and wear hearing protection. Do not sound the siren indoors or in enclosed areas where you and others will be exposed to the sound.

- Federal Signal siren amplifiers and speakers are designed to work together as a system. Combining a siren and speaker from different manufacturers may reduce the warning effectiveness of the siren system and may damage the components. You should verify or test your combination to make sure the system works together properly and meets federal, state and local standards or guidelines.

During Installation

- Do NOT get metal shavings inside the product. Metal shavings in the product can cause the system to fail. If drilling must be done near the unit, place an ESD-approved cover over the unit to prevent metal shavings from entering the unit. Inspect the unit after mounting to be sure there are no shavings present in or near the unit.
- Do NOT connect this system to the vehicle battery until ALL other electrical connections are made, mounting of all components is complete, and you have verified that no shorts exist. If wiring is shorted to vehicle frame, high current conductors can cause hazardous sparks resulting in electrical fires or flying molten metal.
- To avoid a battery explosion, always disconnect the negative battery cable first and reconnect it last. Avoid causing a spark when connecting near to the battery. The gases produced by a battery can cause a battery explosion that could result in vehicle damage and serious injury.
- Be sure the siren amplifier and speaker(s) in your installation have compatible wattage ratings.
- In order for the electronic siren to function properly, the ground connection must be made to the NEGATIVE battery terminal.
- Sound output will be severely reduced if any objects are in front of the speaker. If maximum sound output is required for your application, you should ensure that the front of the speaker is clear of any obstructions.
- Install the speaker(s) as far forward on the vehicle as possible, in a location which provides maximum signaling effectiveness and minimizes the sound reaching the vehicle's occupants. Refer to the National Institute of Justice Guide 500-00 for further information.
- Mounting the speakers behind the grille will reduce the sound output and warning effectiveness of the siren system. Before mounting speakers behind the grille, make sure the vehicle operators are trained and understand that this type of installation is less effective for warning others.
- Sound propagation and warning effectiveness will be severely reduced if the speaker is not facing forward. Carefully follow the installation instructions and always install the speaker with the projector facing forward.
- Do NOT install the speaker(s) or route the speaker wires where they may interfere with the operation of airbag sensors.
- Installation of two speakers requires wiring speakers in phase.
- Never attempt to install aftermarket equipment, which connects to the vehicle wiring, without

Safety Messages

reviewing a vehicle wiring diagram available from the vehicle manufacturer. Insure that your installation will not affect vehicle operation and safety functions or circuits. Always check vehicle for proper operation after installation.

- Do NOT install equipment or route wiring or cord in the deployment path of an airbag.
- If a vehicle seat is temporarily removed, verify with the vehicle manufacturer if the seat needs to be recalibrated for proper airbag deployment.
- Locate the control head so the vehicle, controls, and microphone can be operated safely.
- When drilling into a vehicle structure, be sure that both sides of the surface are clear of anything that could be damaged.

After Installation

- After installation, test the siren system and light system to ensure that it is operating properly.
- Test all vehicle functions, including horn operation, vehicle safety functions and vehicle light systems, to ensure proper operation. Ensure that the installation has not affected vehicle operation or changed any vehicle safety function or circuit.
- After testing is complete, provide a copy of these instructions to the instructional staff and all operating personnel.
- File these instructions in a safe place and refer to them when maintaining and/or reinstalling the product.

Failure to follow all safety precautions and instructions may result in property damage, serious injury, or death.

RETAIN AND REFER TO THESE MESSAGES

CHAPTER 2

Preparing to Program the Control Pad

⚠ WARNING

PRECAUTIONS FOR CONFIGURING THE SMARTSIREN PLATINUM CONTROL PAD

Property damage, serious injury, or death may result if the SmartSiren Platinum control pad is improperly configured. Configuration is to be performed at the time of the software installation. It is NOT intended for operators to “customize” the operation of the control pad for their individual preferences. It is the installer’s responsibility to determine compatibility, suitability, and ensure proper programming of the system. In addition, the person responsible for programming MUST be familiar with local codes and procedures for the safe operation of emergency-vehicle siren and lights.

System Requirements

The SmartSiren Platinum Configuration Software is supported on laptops and desktops meeting these minimum requirements:

- 1 GHz Pentium® 3 processor or compatible (32-bit and 64-bit)
- Microsoft Windows® XP with Service Pack 2, Windows Vista or Windows 7 (32-bit and 64-bit versions)
- 512 MB RAM for Windows XP
1 GB RAM for Windows Vista and Windows 7
Depending on your system, more memory may be required.
- 15 MB available disk space
- 1024 x 768-pixel monitor resolution, 16-bit display (32-bit recommended)
- CD-ROM drive
- One free RJ-45 Ethernet port for connection to the SmartSiren Platinum control pad with the included Ethernet cable (Federal Signal part number 1751532)

This chapter explains how to install the SmartSiren Platinum Configuration Software on your computer. It also explains how to establish an IP address between the control pad and your computer in Windows XP, Windows Vista and Windows 7. A local area connection (LAN) is not needed because the SmartSiren Platinum Configuration software creates a network between your computer and the control pad. Finally, the chapter walks you through the process of setting up the control pad for programming. To wire the control pad for 12 Vdc power, which is needed for programming, refer to the *SmartSiren Platinum Installation, Maintenance, and Service* manual, document number 2562502 or the *Quick Connect Guide*, document number 2562417.

Before you begin programming the SmartSiren Platinum control pad, read this manual to understand the programming process and decide how you want the control pad to operate. To help you plan your configuration, a worksheet provided in the appendix on page 116. After you finish programming the control pad, you can also print a copy of each configuration window. See "Printing a Record of Your Configuration File" on page 99.

Installing the Software

To install the control pad configuration software:

1. Close all applications that are running on your computer.

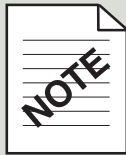

Uninstall the SmartSiren Platinum Configuration Software

If you have a version of the SmartSiren Platinum software installed on your computer, uninstall the software before installing the latest version by selecting **Start > Control Panel > Add or Remove Programs > SmartSiren Platinum 3000 > Remove**.

2. Insert the SmartSiren Platinum Series CD into your CD or DVD drive.
3. When the InstallShield® Wizard appears, click **Next** to continue. Follow the on-screen instructions to complete the installation. If the InstallShield Wizard does not appear automatically, navigate to the CD-ROM drive and double-click **setup.exe**. If you are using Windows Vista, right-click **setup.exe** and choose **Run as Administrator**.

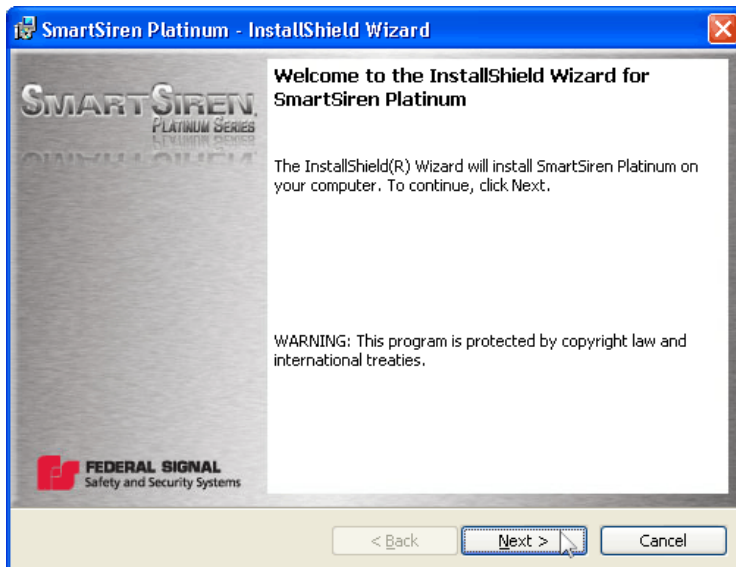

4. Create and name a folder on your hard drive in which to store your configuration files.

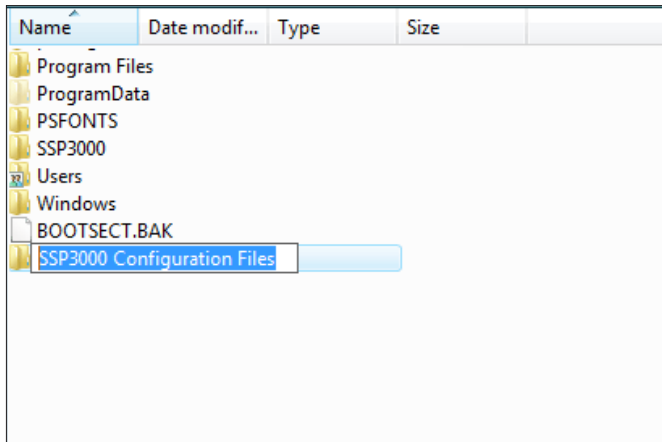

Connecting the Control Pad to Your Computer in Windows XP

This section explains how to establish an IP address between the control pad and your computer in Windows XP after you have installed the SmartSiren Platinum Configuration Software. The network you create by following the steps in this section enables you to program the control pad.

1. In the **Start** menu click **Connect to** and select **Open**.

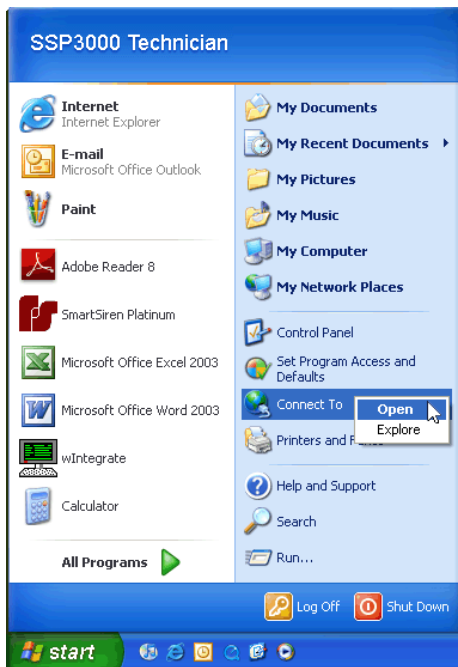

2. Right-click **Local Area Connection** and select **Properties**.

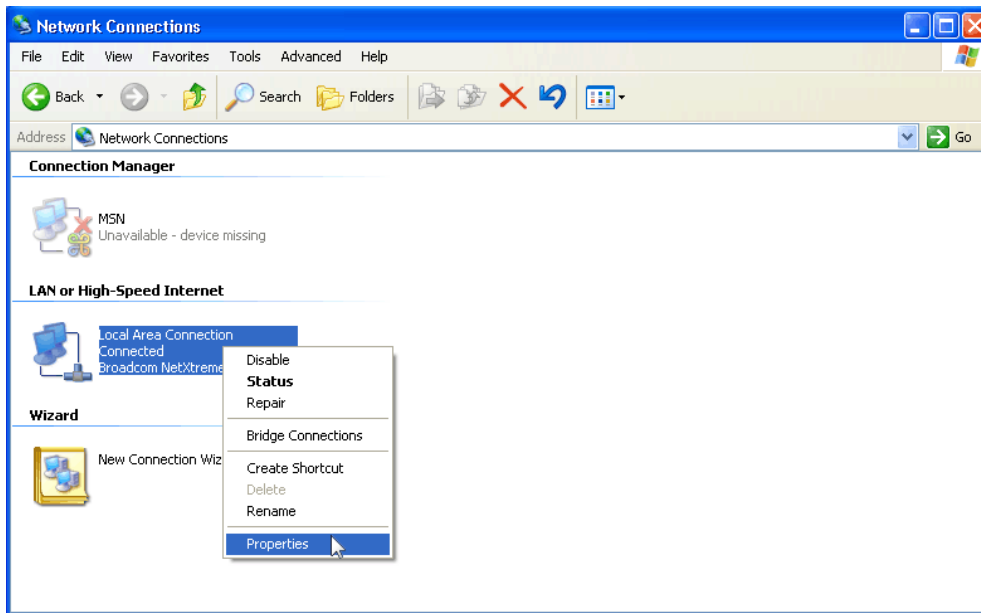

3. Select **Internet Protocol (TCP/IP)** and click **Properties**.

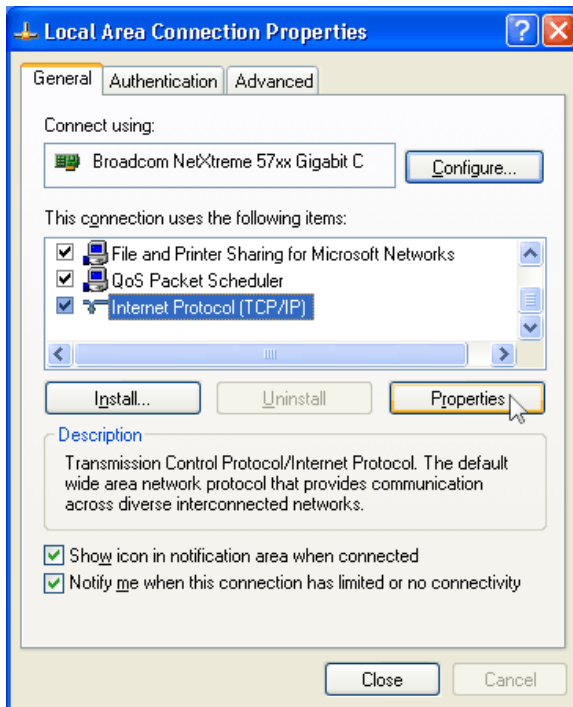

Preparing to Program the Control Pad

4. Select **Obtain an IP address automatically** and **Obtain DNS Server Address Automatically**. Click **OK**.

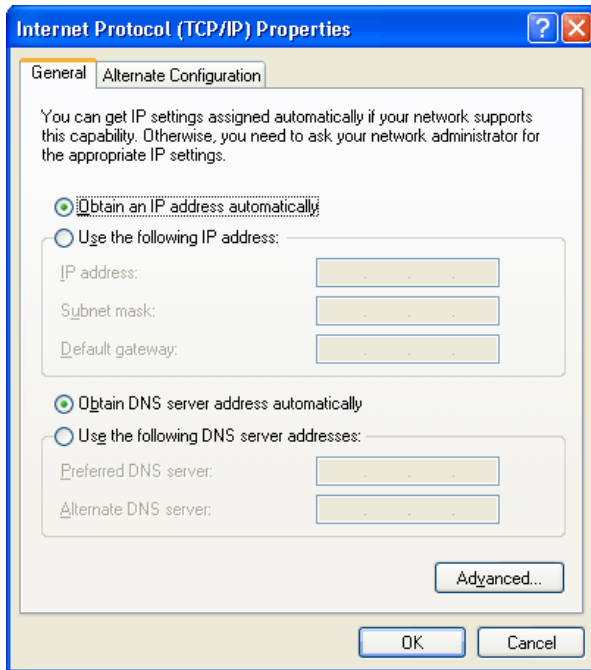

NOTICE

CONTROL PAD DAMAGE

To avoid damage to the control pad, do not plug the black Federal Signal serial cable into the computer programming port on the control pad labeled **PC CONNECT ONLY**.

5. Plug the connector of the orange Ethernet crossover cable into the computer programming port on the side of the control pad.

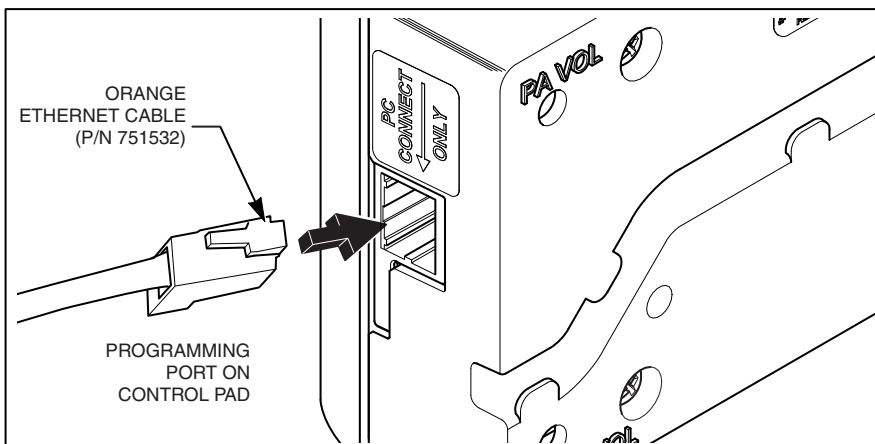

Preparing to Program the Control Pad

6. Plug the other end of the cable into the RJ-485 Ethernet connector on your computer.

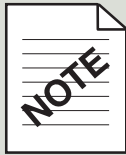
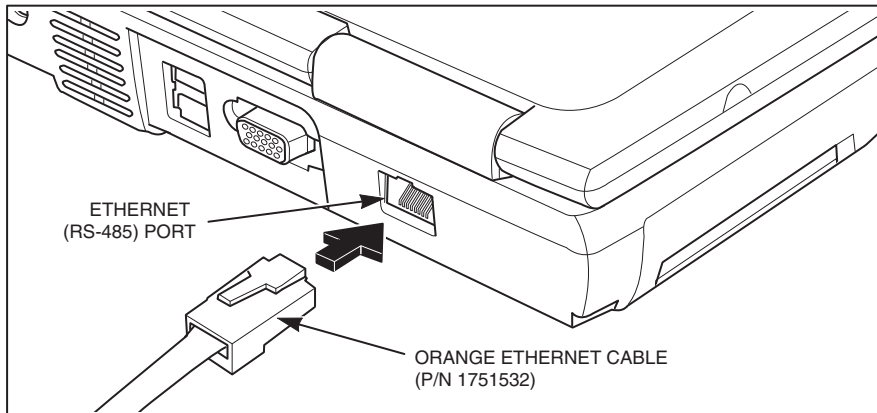

The control pad must be connected to 12 Vdc

To establish the Ethernet connection in the next step, the control pad must be wired for 12 Vdc power. For connection instructions, refer to the *SmartSiren Platinum Installation, Maintenance, and Service* manual, document number 2562502 or the *Quick Connect Guide*, document number 2562417.

7. Set up the control pad for programming by putting it into Program Mode:
 - a) Press and hold **Button 6** while powering up the control pad.

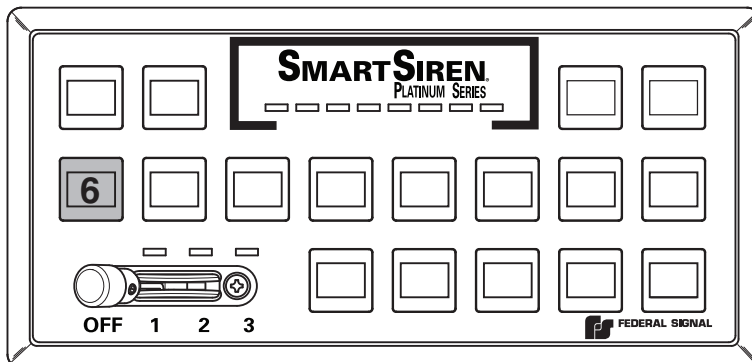

- b) During the long beep, release **Button 6**.
- c) Press **Button 6** again. The first LED on the control pad lights to indicate you are in Programming Mode.

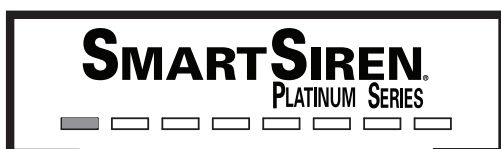

- d) Press **Button 13**. In approximately 30 seconds the first LED blinks and the control pad beeps to indicate that your Ethernet port is on.

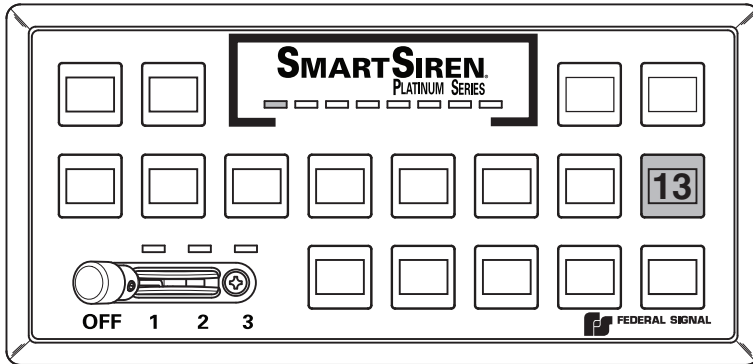

If you cannot connect to the Convergence Network, refer to the troubleshooting instructions in the appendix on page 103.

Connecting the Control Pad to Your Computer in Windows Vista/7

This section explains how to establish an IP address between the control pad and your computer in Windows Vista and Windows 7 after you have installed the SmartSiren Platinum Configuration Software. The network you create by following the steps in this section enables you to program the control pad.

1. In the **Start** menu, right-click **Network** and select **Properties**.

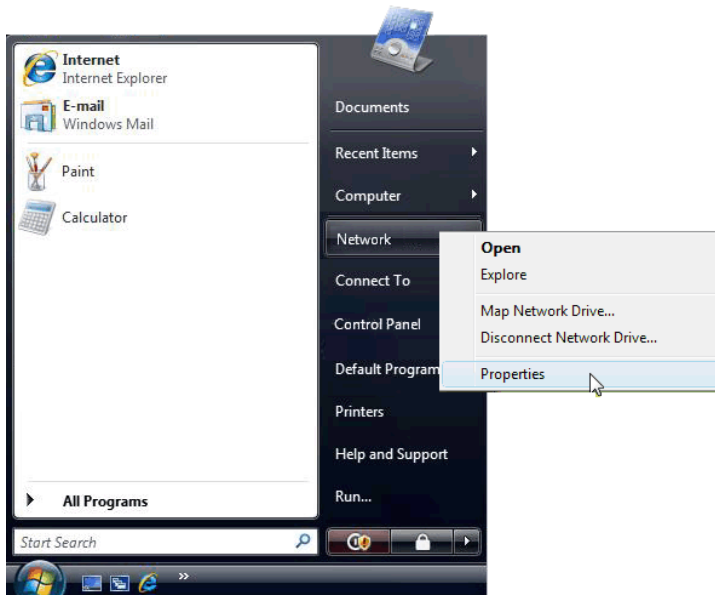

- In the **Network and Sharing Center**, click the link **Manage Network Connections**.

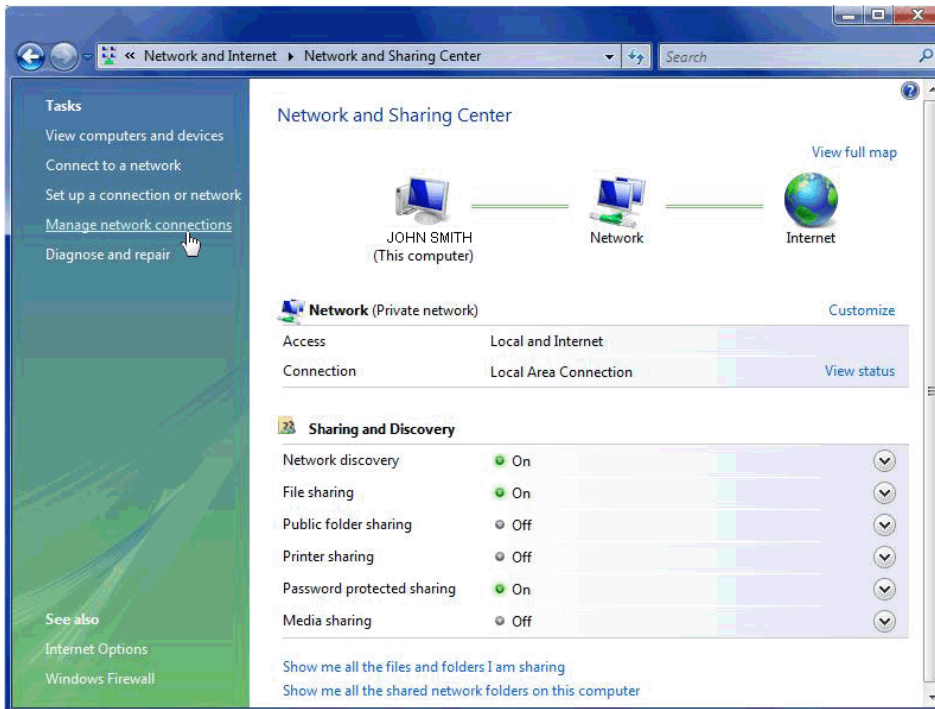

- Right-click your **Local Area Connection** and select **Properties**.

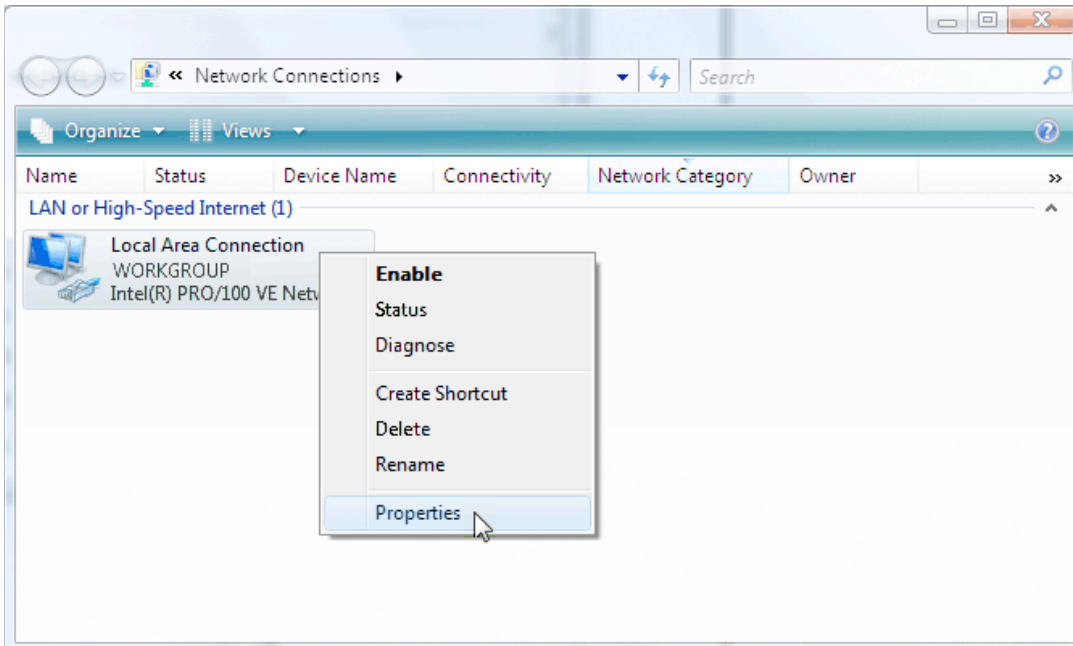

4. Select **Internet Protocol Version 6** and click **Properties**.

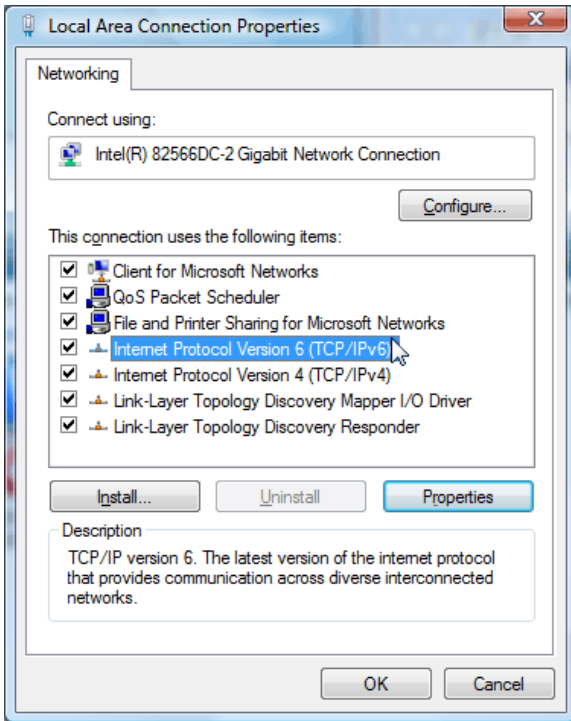

5. Select **Obtain an IPv6 address automatically** and click **OK**.

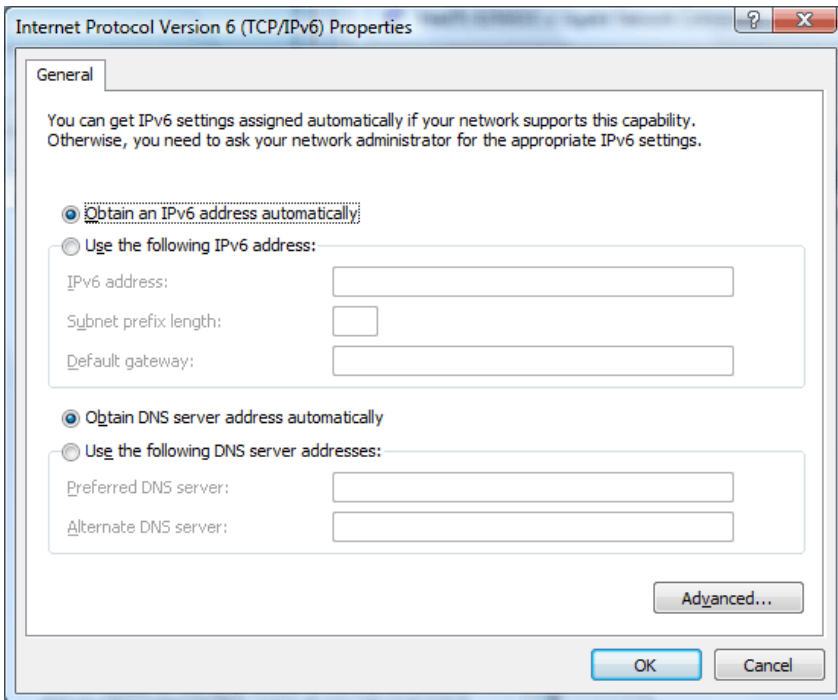

NOTICE

CONTROL PAD DAMAGE

To avoid damage to the control pad, do not plug the Federal Signal serial cable into the computer programming port on the control pad labeled PC CONNECT ONLY.

6. Plug the connector of the orange Ethernet crossover cable into the computer programming port on the side of the control pad.

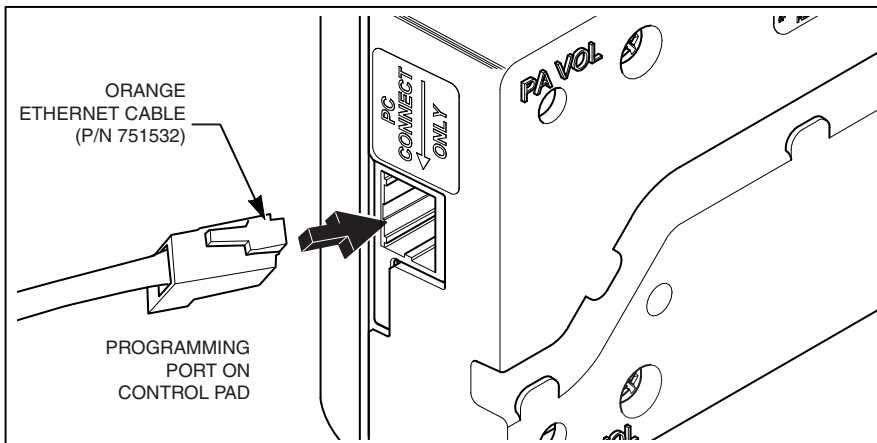

7. Plug the other end of the cable into the RJ-485 Ethernet connector on your computer.

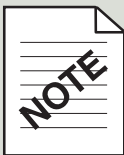
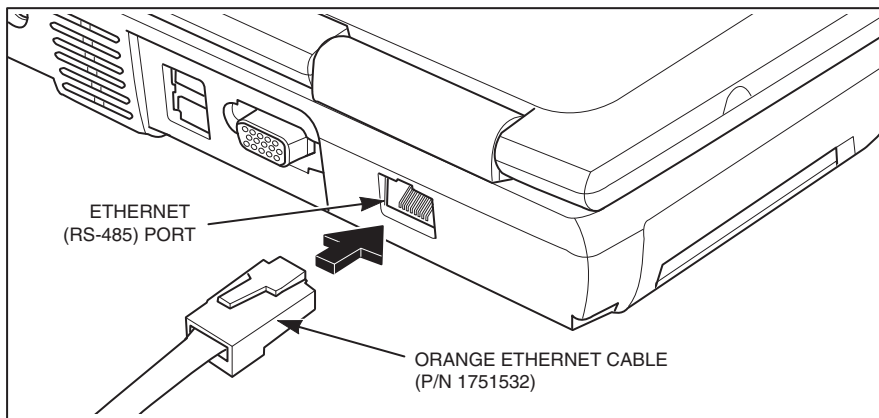

The control pad must be connected to 12 Vdc

To establish the Ethernet connection in the next step, the control pad must be wired for 12 Vdc power. For connection instructions, refer to the *SmartSiren Platinum Installation, Maintenance, and Service* manual, document number 2562502 or the *Quick Connect Guide*, document number 2562417.

Preparing to Program the Control Pad

8. Set up the control pad for programming by putting it into Program Mode:
 - a) Press and hold **Button 6** while powering up the control pad.

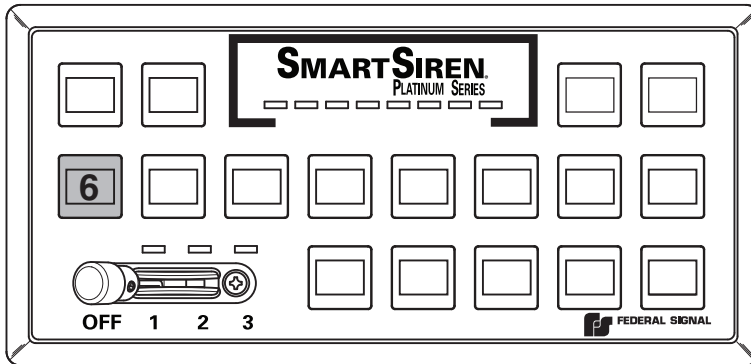

- b) During the long beep, release **Button 6**.
 - c) Press **Button 6** again. The first LED on the control pad lights to indicate you are in Programming Mode.

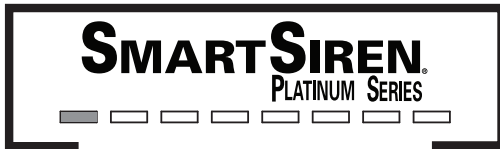

- d) Press **Button 13**. In approximately 30 seconds the first LED blinks and the control pad beeps to indicate that the Ethernet port is on.

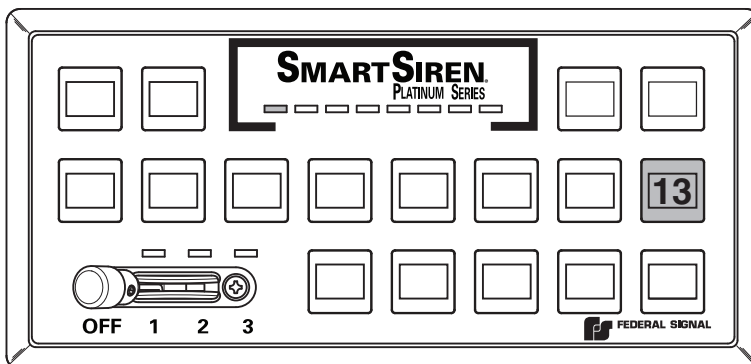

If you cannot connect to the Convergence Network, refer to the troubleshooting instructions in the appendix on page 108.

CHAPTER 3

Exploring the Interface

An Overview of the SmartSiren Platinum Configuration Software

The SmartSiren Platinum 3000 Configuration Software is a Microsoft Windows-based application that enables you to configure how the SmartSiren Platinum control pad and SmartSiren Platinum amplifier operate the Federal Signal warning devices installed in an emergency vehicle. The serial and non-serial controlled warning devices operate as part of a system that communicates through the Federal Signal in-vehicle Convergence™ Network. The devices include:

- SmartSiren Platinum Siren Amplifier/Relay Module
- Model 660100 RS485 Relay Module/Two Channel Flasher
- Lightbars and SignalMaster™ directional/warning lights
- Exterior and interior perimeter warning lights
- Siren, PA, radio, horn-ring transfer
- Automatically activated and timed switches and relays

With the control pad serving as the command center, the SmartSiren Platinum Siren Amplifier/Relay Module acts as the communications hub of the Convergence Network. With solid-state relays and LEDs that light to indicate signal transmission between circuits, the siren amplifier does more than amplify sound. It coordinates the operation and communication of all devices on the network according to the configuration file you created using the configuration software.

The configuration software displays a GUI (graphical user interface) version of the SmartSiren Platinum control pad. The interface also includes programmable button-control versions of the four input relays and horn ring circuit in the SmartSiren Platinum Siren Amplifier. The software enables you to easily choose what functions the buttons control and how devices and buttons operate without having to determine logic or perform complicated rewiring.

The application stores the configuration information in a file on your hard drive in a location of your choice. You can create and name additional configuration files for uploading to the same or other SmartSiren Platinum control pads. For easy reference, you can also print the screen version of your system configuration. The elements that make up the interface are illustrated below and described in the next pages.

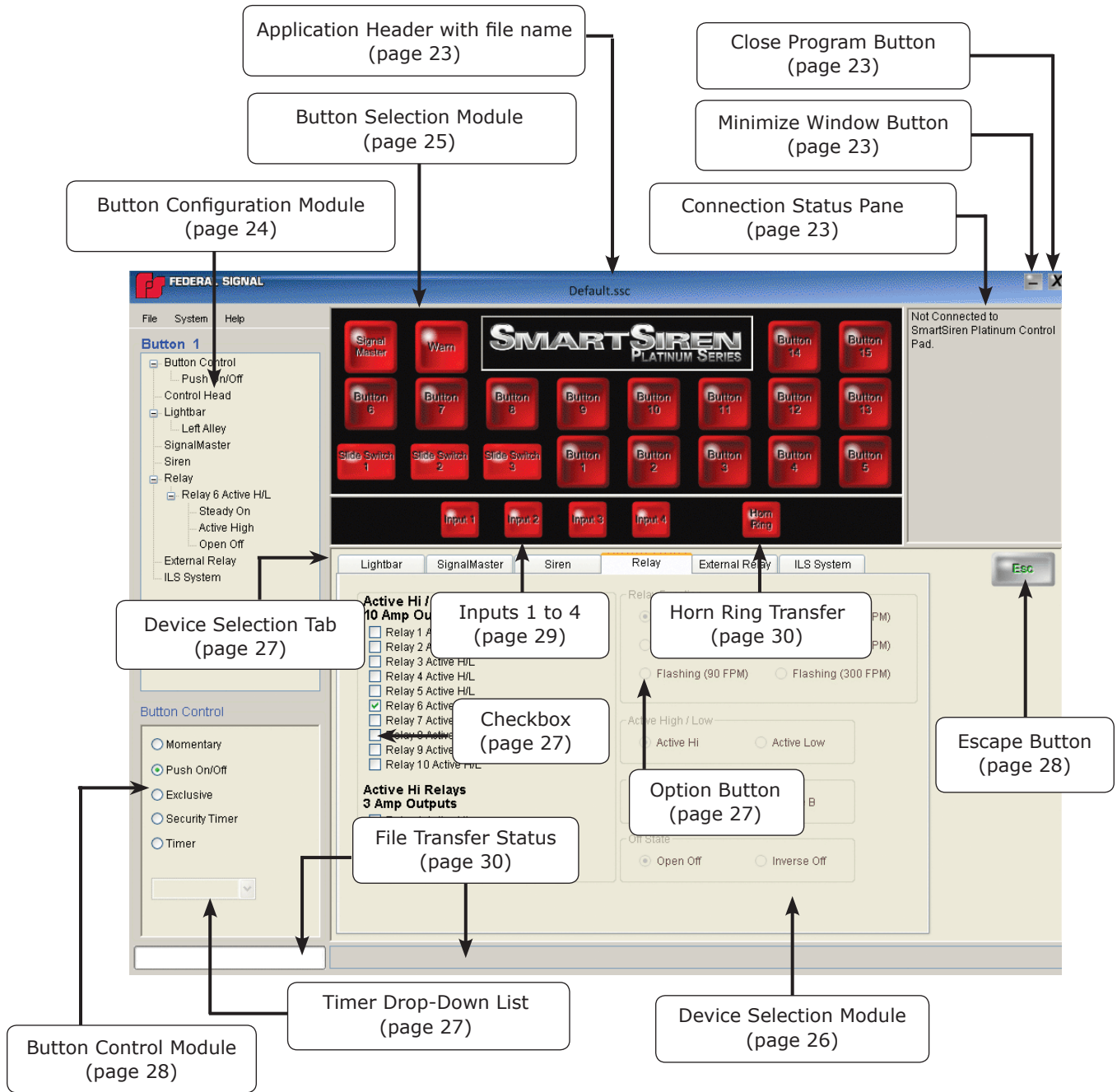

Application Header

The application header at the top of the window displays the file name for the file you open. The example below displays the name of the default configuration file (Default.scc) included with the software that you will modify for your requirements.



Minimize Window (-) Button and Close Program (X) Buttons

One of the first things you will recognize is the **Minimize Window** button and the **Close Program** button in the upper right corner of the interface.



The **Minimize** (-) button works the same way as it does in other Microsoft Windows-based applications. By clicking the button, you shrink the window to an icon on the taskbar. This enables you to tuck away the application without closing it. When you are ready to work with the application, you can quickly access it by clicking the icon.

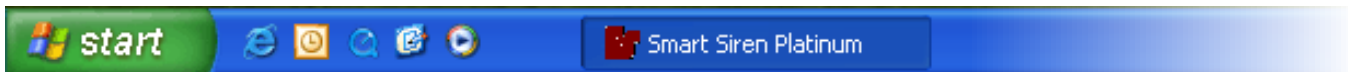

The **Close Program** (X) button works the same as its counterpart in other Windows applications. When you are ready to close the application, click the button. Click **Yes** or **No** in the pop-up box in response to the question "Do you want to save changes to configuration?" In the dialog box that appears in response **Yes**, select a folder for the configuration file, type a new file name, then click **Save**.

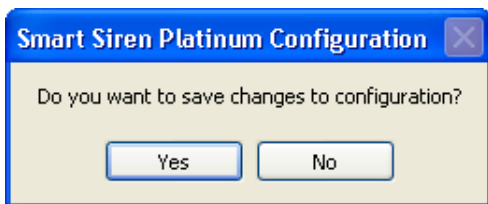

Connection Status Pane

The **Connection Status Pane** in the upper right corner is the first pane to check when using the application. It tells you if the control pad is connected to the Convergence Network. It also displays the firmware version of the control head, and the date and time of the last saved configuration file. The control pad, however, must be connected and powered up to read in a configuration file from your computer. For information on the system's wiring, refer to the *SmartSiren Platinum Installation, Maintenance, and Service* manual, document number 2562502 or the *Quick Connect Guide*, document number 2562417.

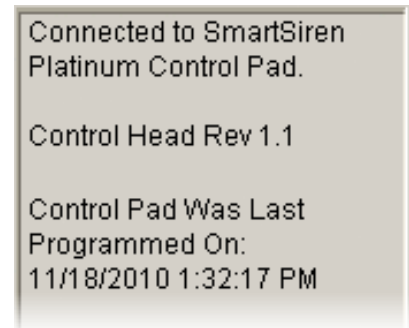

If the control head firmware is incompatible with the version of the configuration software that you are using, an error message appears.

For customer support, please call:

Service Department
Federal Signal Corporation
Phone: 1-800-433-9132
Fax: 1-800-343-9706
Email: emp-service-info@fedsig.com
7 a.m. to 5 p.m., Monday through Friday (CT)

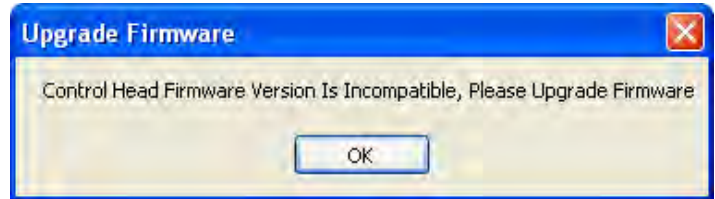

The Four Programming Modules

The SmartSiren Platinum is contained within an integrated workspace, which means each programming module is displayed within a larger window. The four programming modules are: the **Button Configuration Module**, the **Button Selection Module**, the **Device Selection Module**, and the **Button Control Module**. The default configurations are listed in the chapters for each **Device Assignment Pane**. In addition, the appendix has a table on page 116 of the default configurations for every button.

The Button Configuration Module

The **Button Configuration Module** displays all devices available in the Convergence Network. It also displays functions assigned to the devices that are controlled the button shown in the header. The **Button Configuration Module** also displays device assignments for the four **Input** circuits and the **Horn Ring Transfer** circuit as well.

The information is arranged in a directory tree. To expand information about a device, click the plus sign (+) next to it. To collapse the category, click the negative sign (-).

If the tree extends beyond the bottom of the module, a scroll bar appears to the right. Click and hold the bar, then drag it up and down to see the entire tree.

The illustration on the right displays the default settings for **Button 8**. The button is configured to act as a **Push On/Off** switch. When the button is pressed, the perimeter lights connected to **Relay 8** stay on without flashing (**Steady On**). The circuit is supplying +12 Vdc during its "on" state (**Active High**) and is open during its "off" state (**Open Off**).

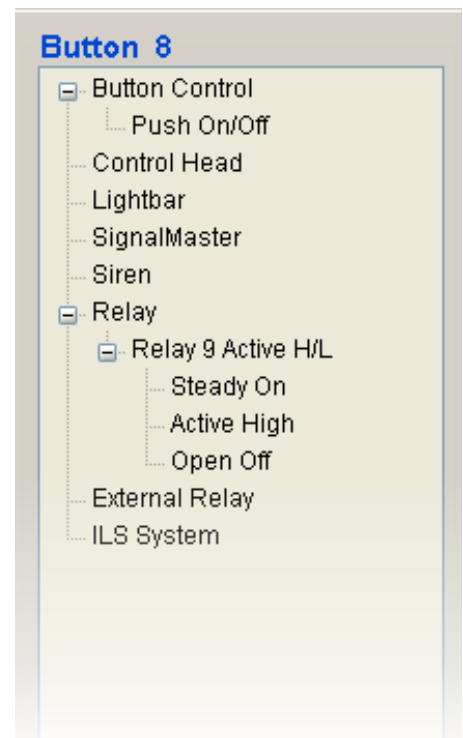

The Button Selection Module

The module is the software version of the 17 buttons and three slide-switch positions on the control pad. It also has “virtual” buttons representing the four **Input** circuits and the **Horn Ring Transfer** circuits available in the SmartSiren Platinum Siren Amplifier. The **Button Selection Module** is the starting point; you must first click a button to make the other options in the **Device Selection Module** available for selection.

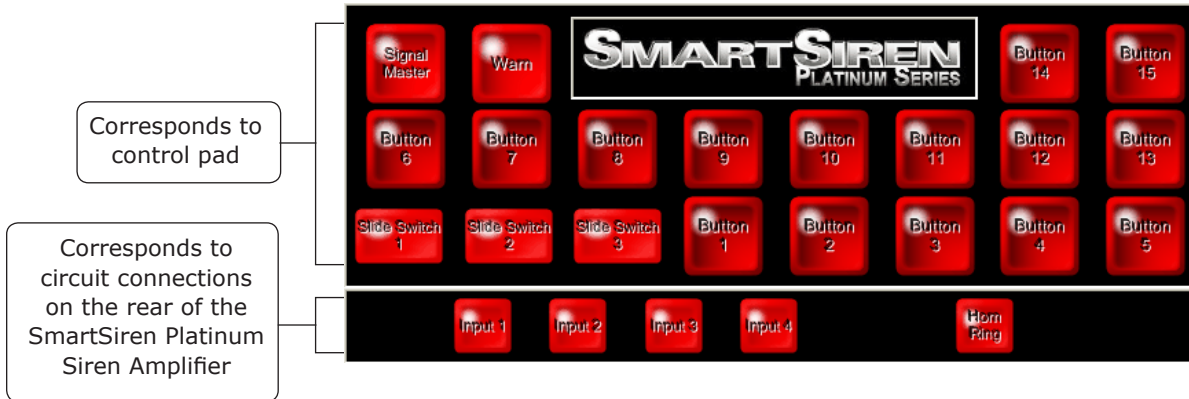

When you assign a function to a button in the **Device Selection Module**, the name of the button and the assigned function are displayed in the directory tree in the **Button Configuration Module** (page 24). Functions include devices, such as lightbars and sirens, and the way the devices operate. You can assign up to ten functions to all buttons except **Slide Switch Position 3**, which has a limit of 20 functions.



You can easily change the name of any button by right-clicking it, dragging the cursor over the default name to highlight it, and typing a new name. The number of characters, including spaces, are limited by the size and shape of the buttons. Specifically, the **SignalMaster** and **Warn** buttons, and **Buttons 1–15**, are limited to 40 characters. The **Slide Switch** buttons are limited to 44 characters, and the **Input** buttons are limited to 24 characters.

Although most buttons work the same, some buttons are dedicated to certain devices or have additional options. These buttons are the **SignalMaster** and **Warn** buttons, the **Slide Switch** buttons, and buttons that also function as timers, which are described in the next three sections. Button control for these unique buttons are discussed further in “The Button Control Module” on page 28. See also “Button Control Capabilities” on page 31.

SignalMaster and Warn Buttons

You can assign a device to any of the buttons except the **SignalMaster** and **Warn** buttons in the upper left corner. The buttons are dedicated to SignalMaster-equipped lightbars or standalone SignalMaster lightbars. The **SignalMaster Pane** in the **Device Selection Module** has options assignable to these buttons. For more information, see “Chapter 5: Configuring the SignalMaster” on page 44.

Slide Switch Buttons

The three **Slide Switch** buttons correspond to the slide switch positions on the control pad. Each position acts as a momentary switch that turns on and off devices assigned to them. To program the slide switch to operate as a progressive switch, assign the same functions from the previous slide switch position to the next position, then add new functions. Up to ten functions can be assigned directly to **Slide Switch 1** and **2**, and up to twenty to **Slide Switch 3**.

In addition, **Buttons 1** to **5** and **Buttons 14** and **15** can be programmed to activate when the operator puts the slide switch into a position linked to one or more of these buttons. This feature enables the operator to turn functions on and off or skip steps in selecting a step-through SignalMaster warn or directional pattern without changing the position of the slide switch. Linking a button also extends the number of assignable functions available to a slide switch button with the additional 10 functions of the linked button. The pane below shows the buttons available for activation when a slide switch button is selected.

The Device Selection Module

The **Device Selection Module** is where you assign devices and functions to the buttons in the **Button Selection Module**. The devices, identified by tabs at the top of their panes are: **Lightbar**, **SignalMaster**, **Siren**, **Relay**, **External Relay**, and **ILS System**. The functions determine how and what they turn on, operate, and turn off. By default, each time you launch the application, it opens with the **Lightbar** pane. The pane that is ready for configuration moves in front of the other panes. The lightbar pane and the others behind it, however, are not active, and therefore not configurable, until you click a button in the **Button Selection Module**.

The screenshot shows the 'Relay' configuration pane in the 'Device Selection Module'. At the top, there are tabs for 'Lightbar', 'SignalMaster', 'Siren', 'Relay', 'External Relay', and 'ILS System'. The 'Relay' tab is selected and highlighted in orange. Below the tabs, there are two sections of checkboxes: 'Active Hi / Low Relays 10 Amp Outputs' and 'Active Hi Relays 3 Amp Outputs'. The first section has checkboxes for Relay 1 through 10, with Relay 1, 2, and 3 checked. The second section has checkboxes for Relay 1 through 4, all of which are unchecked. To the right of these sections are various function options, including 'Steady On', 'Flashing (120 FPM)', 'Flashing (75 FPM)', 'Flashing (200 FPM)', 'Flashing (90 FPM)', and 'Flashing (300 FPM)'. There are also options for 'Active High / Low' (Active Hi, Active Low) and 'Phase A / B' (Phase A, Phase B). At the bottom right, there is a 'Update' button and an 'Open Off' option. On the far right, there is a vertical stack of buttons labeled 'Activate', including 'Button 1' through 'Button 5', 'Button 14', and 'Button 15'. A green 'Esc.' button is located at the top right of the interface. Several callout boxes provide instructions: 'Select a tab to access a device. The tab is lighter in color to indicate that the pane available for configuration. The orange bar is added in Windows XP.' points to the 'Relay' tab. 'The flow of the selection process is right to left. Click a box or option button to select or deselect.' points to the 'Relay' tab and the 'Active Hi / Low Relays' section. 'Esc is green to indicate the pane is active and can accept your selections' points to the 'Esc.' button. 'Options are dimmed until you select a device' points to the 'Flashing (300 FPM)' option. 'Options are grouped by device, function, and similarity.' points to the 'Active Hi / Low Relays' and 'Active Hi Relays' sections. 'Buttons for activation by a slide switch position appear when a slide switch button is selected.' points to the 'Activate' buttons.

Device Selection Tabs

To select a pane in background, click the **Device Selection Tab** on the top of the pane. The tab of an active pane is lighter than the others. In addition, in Windows XP the tab is topped with an orange bar

To help you find what you need, devices and their functions are grouped by similarity. For example, in the **SignalMaster** Pane lightbar types, SAE and non-SAE warn patterns, and speed and dimming options are grouped within boxes. A gap also separates **Front** and **Rear SignalMaster** types.

In general, the direction in which you select items is from devices on the right of the pane to functions on the left. Options that are dimmed and disabled become available as you select the devices that use them.

In some panes a device or option is unavailable because it is already assigned. To prevent duplication, for example, a siren tone that is assigned to a button in the **Siren** Pane remains unavailable until you reassign it to a new button.

Option Buttons and Checkboxes

Most devices and functions are selected by clicking the empty **option button** or **checkbox** next to them to insert a dot or a checkmark. To de-select them, click the selected option button or checkbox to clear it.

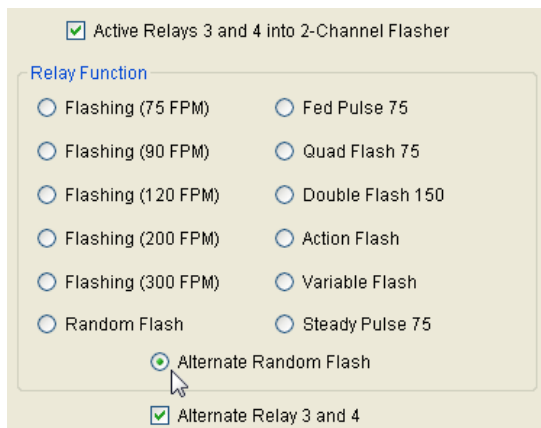

Drop-Down Lists

Drop down lists are for functions that have many choices, such as flash patterns and timer settings. To select a function from a drop-down list, click the arrow next to the list box and move your cursor over a function in the drop-down list to highlight it. The box displays your selection.

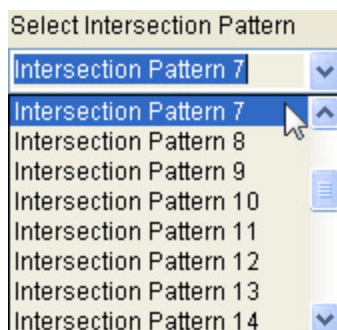

Escape Button



When you click a button in the **Button Control Module** for the first time, the legend **Esc** on the **Escape** button in the upper right corner of the **Device Selection Module** changes from gray to green. The change in color lets you know that the pane is active and ready for your selections.

The **Escape** button enables you to cancel your changes in a pane while returning you to the **Lightbar Pane**. You can also use the button to deselect default settings or your saved settings in a pane with one click.

To cancel your changes in a pane after clicking the **Escape** button, click **OK** in the **Saving Button Configuration** pop-up. To keep your selections, click **Cancel** or the **X** in the popup.

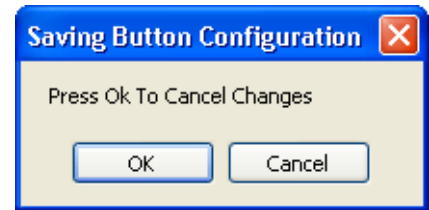

The Button Control Module

The **Button Control Module** enables you to select how a button operates when pressed. See also "Button Control Capabilities" on page 31.

- as a **Momentary** button that turns on a function when pressed and held, and turns off the function when released.
- as a **Push On/Off** button that turns on a function when pressed and turns off the function when pressed again.
- as an **Exclusive** button that turns on a function when pressed and turns off the button that was pressed previously in the same row.
- as a **Security Timer** that requires the sequential press of two buttons to turn on a function that turns off after a set duration. The first button, which is the **Security Timer**, must be selected from the buttons with the capability shown in the table on page 31. The drop-down list of timer durations has a choice of 4, 8, 12, 16, and 20 seconds.

To turn on the security timer, **Button 14**, which is the second "enable" button, must be pressed within 4 seconds after the first button is pressed. If **Button 14** controls another function, such as a lightbar flash pattern, a second press of **Button 14** turns on the function.

To turn off the **Security Timer**, press the first button again or let it time out.

- as a **Timer** with a set duration for a function to stay on. The durations are the same as for the **Security Timer**.

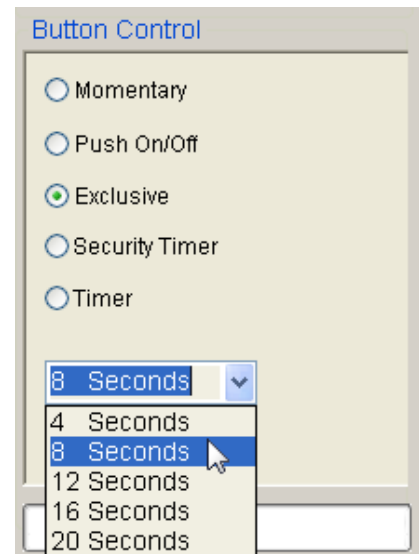

The **Button Control Module** is not available for:

- the **SignalMaster** button because the button acts as a **Push On/Off** switch that controls the default step-through warning patterns. The button controls only the “step-through” selection of the Left, Right, Center Out directional patterns. A step-through button activates a flash pattern, siren tone, or other function in a sequence each time you press it, starting with the first function.
- the SignalMaster **Warn** button because the it functions as a **Push On/Off** switch that selects one warn pattern or functions as a button that steps through the assignment of two or more warn patterns.
- the slide switch because each switch position acts as a momentary button.

Inputs 1 to 4

You can assign to the **Input** buttons any of the devices and functions in the **Device Selection Module**. Each input button corresponds to one of the four input connections on the back of the SmartSiren Platinum Siren Amplifier. The connections are located below the pins for the discrete SignalMaster. **Input 1** and **2** are active-low inputs that activate a switch when pulled to ground. **Input 3** and **4** are active-high inputs that activate a switch when pulled to 12 Vdc battery voltage. The inputs are most commonly used for switches that send a signal to the SmartSiren Platinum system when a condition in the vehicle changes. Changes may include the opening of a trunk or door, a rise in vehicle temperature, or the release of a gun lock.

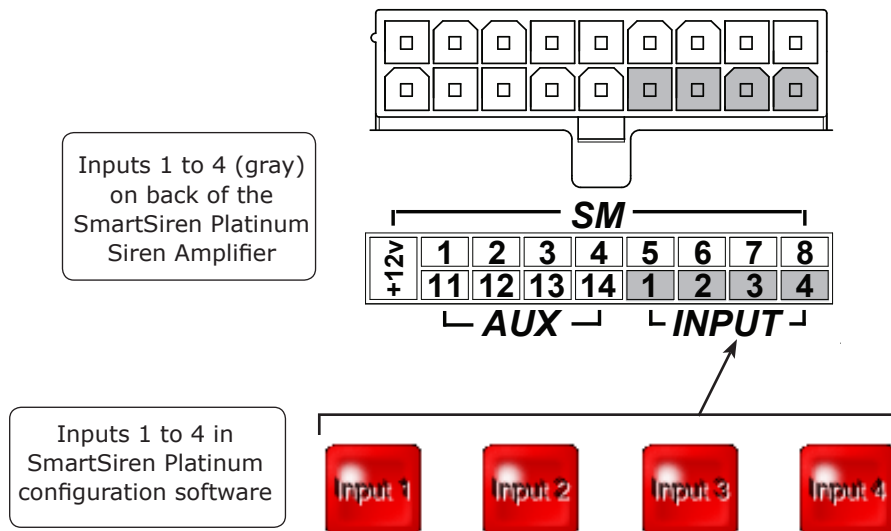

Horn Ring

The **Horn Ring** button is for the horn-ring transfer circuit connected through pins 2 and 8 on the 12-pin connector on the SmartSiren Platinum siren amplifier. The default setting for the slide switch is to transfer the horn ring activation of the siren in **Slide Switch 2** and **3**. Each press of the horn button on the steering wheel steps through the **Siren Function** selected for the **Horn Ring** button. In addition, **Slide Switch 2** is configured as **Siren Dependent Enabled**.

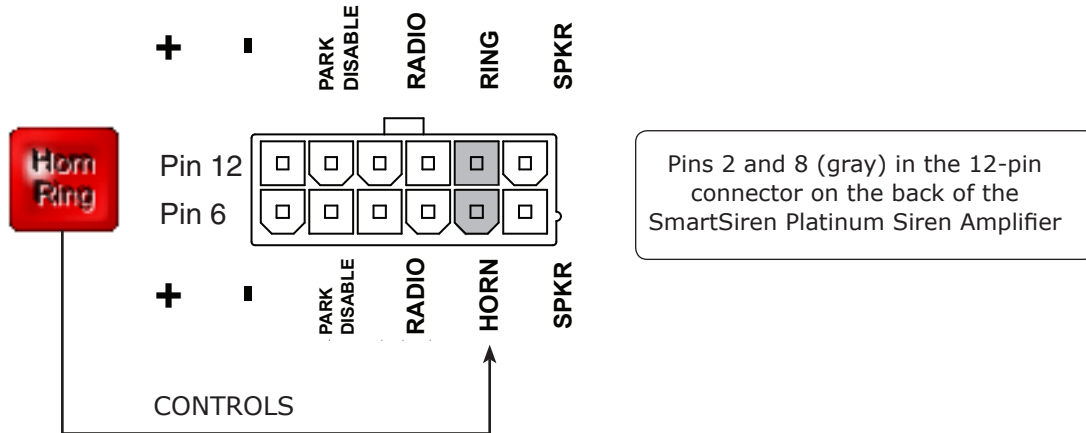

File Transfer Status Panes

The **File Transfer Status** Panes at the bottom of the SmartSiren Platinum 3000 Configuration Software window displays information about the transfer progress of configuration files between the control pad and your computer.

Uploading Configuration Files

The file upload process begins when you select **Program Control Head** from the **System** menu. The uploaded file replaces the file in the flash memory of the control pad. The file is ready to control the configured devices in the Convergence Network. For additional menu commands, see the table on page 32.

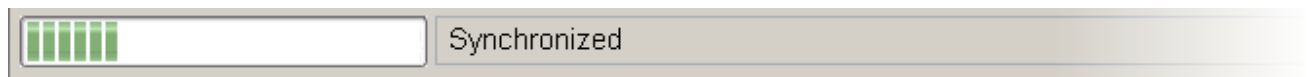

Downloading Configuration Files

The file download process begins when you select **Read Control Pad Configuration** from the **System** menu. The command transfers a configuration file from the control pad to your computer for editing.

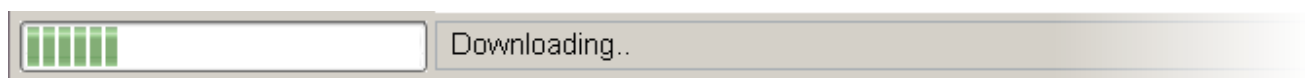

The next chapters describe how to configure the control pad using each pane in the **Device Selection Module**. For an overall view of the default settings, see the table on page 115.

Button Control Capabilities

The table below shows the choices for how a button and circuit can operate when activated, the number of functions available, and the character limit of the user-defined button legends.

Buttons 1 to 5 and **Buttons 14** and **15** can be programmed to activate when the operator puts the slide switch into a position linked to one or more of these buttons.

SignalMaster SignalMaster Types Step Through Selection of SAE Warn Patterns: Left, Right, Center-Out 40 characters	Warn Warn Patterns 1-14 Up to four step-through selections Push On/Off for one selection 40 characters	<div style="text-align: center;">  <p>SMARTSIREN® PLATINUM SERIES</p> </div>				Button 14 Momentary Push On/Off Security Timer Timer 10 functions 40 characters	Button 15 Momentary Push On/Off Security Timer Timer 10 functions 40 characters
Button 6 Momentary Push On/Off Exclusive 10 functions 40 characters	Button 7 Momentary Push On/Off Exclusive 10 functions 40 characters	Button 8 Momentary Push On/Off Exclusive 10 functions 40 characters	Button 9 Momentary Push On/Off Exclusive 10 functions 40 characters	Button 10 Momentary Push On/Off Exclusive 10 functions 40 characters	Button 11 Momentary Push On/Off Exclusive 10 functions 40 characters	Button 12 Momentary Push On/Off Exclusive 10 functions 40 characters	Button 13 Momentary Push On/Off Exclusive 10 functions 40 characters
Slide Switch 1 10 functions Momentary Progressive Can attach functions of Buttons 1-5, 14, 15, SignalMaster, and Warn 44 characters	Slide Switch 2 10 functions Momentary Progressive Can attach functions of Buttons 1-5, 14, 15, SignalMaster, and Warn 44 characters	Slide Switch 3 20 functions Momentary Progressive Can attach functions of Buttons 1-5, 14, 15, SignalMaster, and Warn 44 characters	Button 1 Momentary Push On/Off Exclusive Security Timer Timer 10 functions 40 characters	Button 2 Momentary Push On/Off Security Timer Timer 10 functions 40 characters	Button 3 Momentary Push On/Off Security Timer Timer 10 functions 40 characters	Button 4 Momentary Push On/Off Security Timer Timer 10 functions 40 characters	Button 5 Momentary Push On/Off Security Timer Timer 10 functions 40 characters

Input 1 Active Low Momentary Push On/Off Security Timer Timer 24 characters	Input 2 Active Low Momentary Push On/Off Security Timer Timer 24 characters	Input 3 Active High Momentary Push On/Off Security Timer Timer 24 characters	Input 4 Active High Momentary Push On/Off Security Timer Timer 24 characters
--	--	---	---

Horn Ring On Power Up 24 characters
--

Menu Commands

File Menu

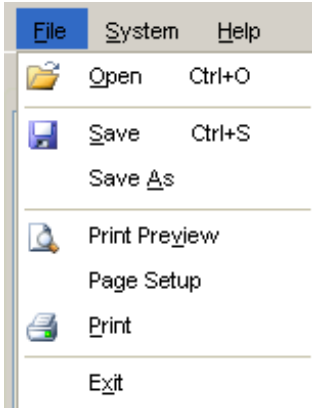

Open: Enables you to select and open a configuration file stored on your hard drive and loads it the random access memory (RAM) of your computer for editing or uploading to the control pad.

Save: Saves a configuration file over the open configuration file.

Save As: Saves a configuration file in a location of your choice.

Print Preview: Displays and zooms a preview of the page layout of the SmartSiren Platinum interface.

Page Setup: Opens a dialogue box of print settings that you can set to print a copy of the selected configuration window.

Print: Prints a copy of the configuration window.

Exit: Closes the SmartSiren Platinum software application without saving the configuration file.

System Menu



System Option: Loads the default configuration file containing the factory settings.

continued on next page

Menu Commands (continued)

System Menu

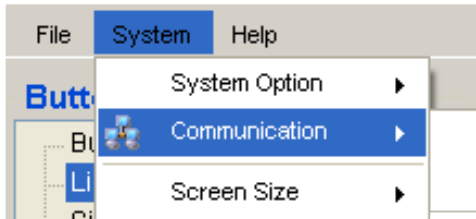

Communication > Program Control Pad:

Uploads a configuration file from your computer to the flash memory of the control head to control devices on the network.

Program Control Head
Read Control Head Configuration

Read Control Pad Configuration: Downloads the configuration file from the control head to your computer so that you can edit it.

System Menu

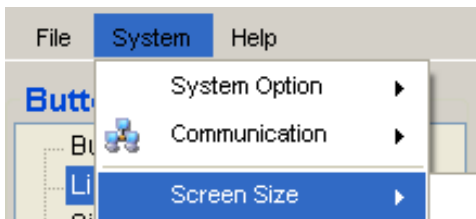

Screen Size: Enables you to determine how large the SmartSiren Platinum application interface appears on the screen. Your screen resolution must be set to at least 1024 x 768 pixels to display the **Large** size.

Small (800 x 600)
Large (1024 x 768)

Help Menu

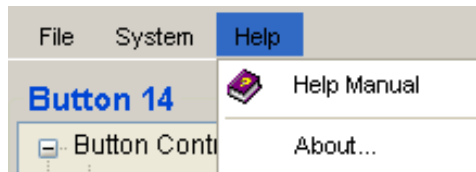

Help Manual: Displays a pdf of the control pad configuration software manual.

About: Displays the software version, description, and copyright.

CHAPTER 4

Configuring the Lightbar

An Overview of the Lightbar Pane

The lightbar pane is the first pane to appear when you launch the application. It has selections for a full-featured, serially-controlled lightbar, such as the Federal Signal Arjent® S2, Legend®, Raydian® S2, Valor™, and Vision™ SLR. The lightbar auxiliary functions in the pane are not dimmed because you can assign them to more than one button. For example, if the takedown lights are assigned to **Button 2**, they remain available for assignment to other buttons.

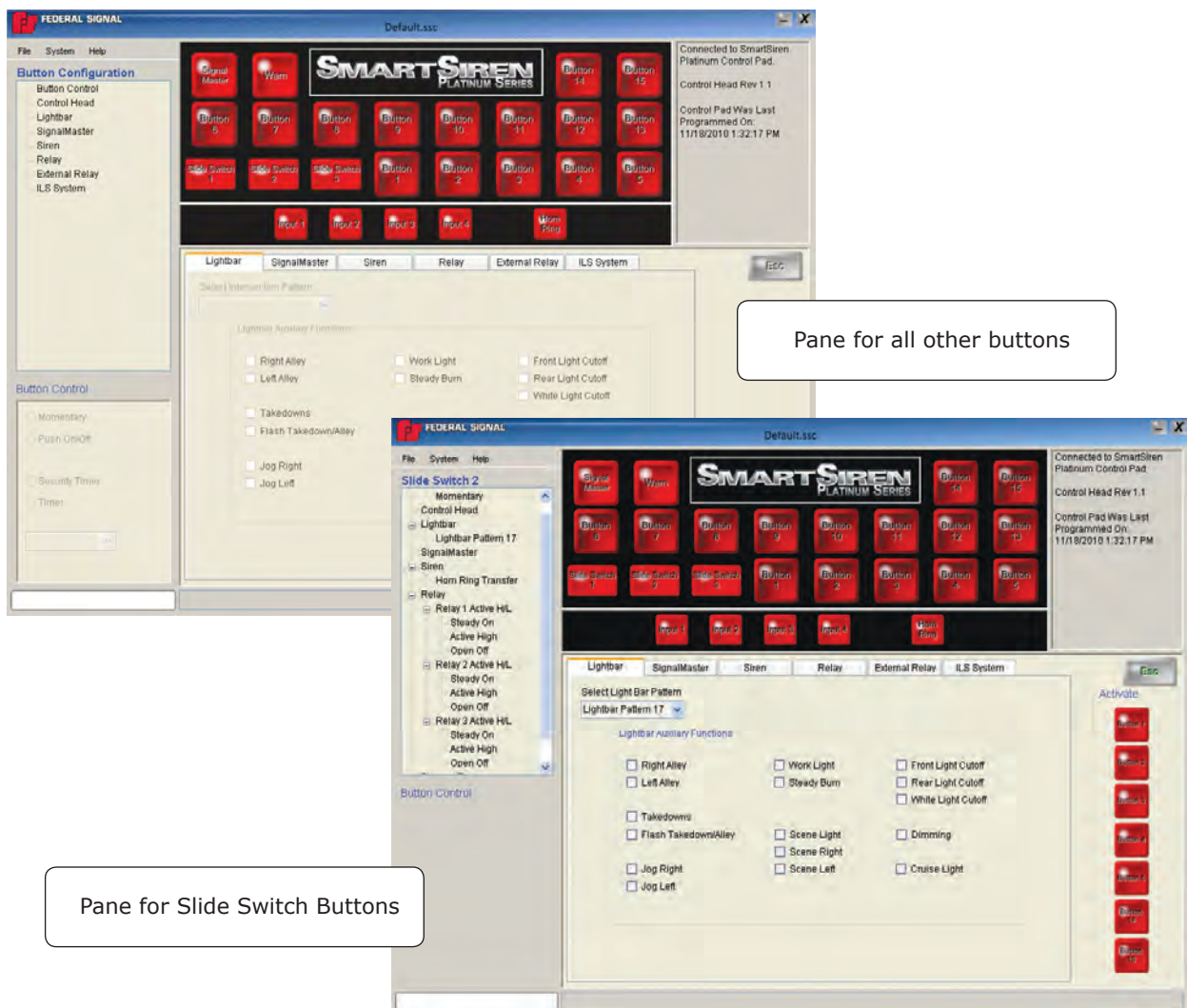

Lightbar Default Settings

Before you begin, you may want to review these lightbar default settings. For an keypad view of the default settings, see the table in the appendix on page 115.

Button	Button Control	Pattern	Auxiliary Function
Slide Switch 1	Momentary*	Lightbar Pattern 10	Front Light Cutoff
Slide Switch 2	Momentary*	Lightbar Pattern 17	
Slide Switch 3	Momentary*	Lightbar Pattern 26	Flash Takedown/Alley
Button 1	Push On/Off		Left Alley
Button 2	Push On/Off		Takedowns
Button 3	Push On/Off		Right Alley
Button 4	Timer	Intersection Pattern 22	
Button 14	Push On/Off		Dimming
Button 15	Push On/Off		Rear Light Cutoff

* The **Button Control Module** is not available because the option cannot be changed.

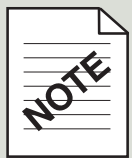

Verify features before configuring the lightbar

Federal Signal lightbars may not have all the features available in the lightbar pane. To make the software configuration of the control pad quick and accurate, determine what hardware features and DIP switch settings are in the lightbar before you begin.

Assigning Lightbar Functions to Buttons

Buttons 1 to 5 and **Buttons 14** and **15** can be programmed to activate when the operator puts the slide switch into a position linked to one or more of these buttons. If you are configuring this feature, first determine which buttons and functions to activate and their corresponding slide switch positions. See "Linking Buttons to Slide Switch Positions (Lightbar Pane)" on page 39.

To assign lightbar functions:

1. Click any button except **SignalMaster** and **Warn**:

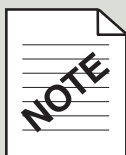

Button Function Limits

The functions for all buttons (except **Slide Switch 3**, which accepts a limit of 20) are limited to a maximum of 10.

Configuring the Lightbar

2. If the lightbar pane is not in front of the other **Device Selection** panes, click the **Lightbar** tab.

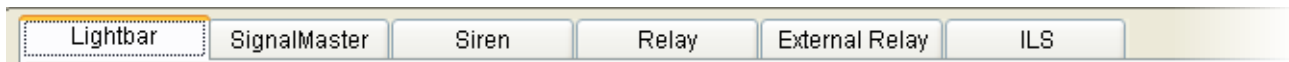

3. Select how you want the button to operate by clicking an option button in the **Button Control** pane. If you want the button to act as a timer, select the duration from the drop-down list.

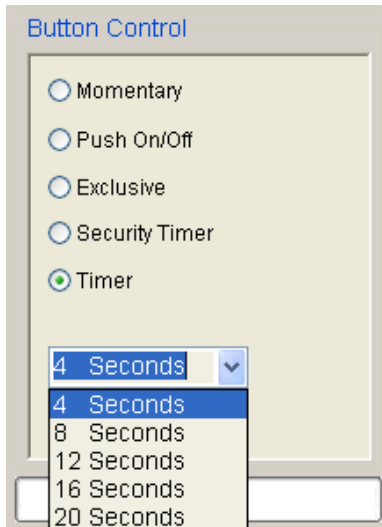

4. Click the arrow next to the drop-down list of 30 flash patterns. Move your cursor over a pattern to highlight and select it. The SmartSiren Platinum Siren Amplifier mimics the corresponding flash pattern number available in the lightbar model on the Convergence Network.

The flash patterns are classified as either **Lightbar** for the **Slide Switch** buttons or **Intersection** for all other buttons except **SignalMaster** and **Warn**. They are the same patterns; the different classification emphasizes how they are used. The intersection pattern is typically a high activity pattern that is assigned to a **Timer** button with an eight second duration.

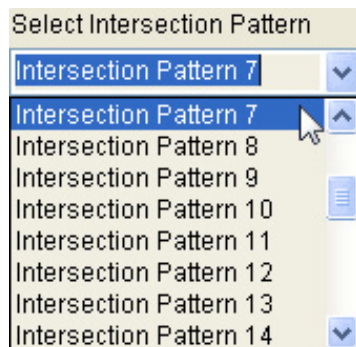

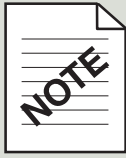

Available flash patterns

Some lightbars have fewer or more flash patterns than are available in the drop-down list. Lightbars that have fewer patterns are restricted to the last pattern available in the pattern library within the lightbar. Lightbars that have more patterns are restricted to the number available in the drop-down list.

For more information about flash patterns, consult the instruction manual for your model of lightbar.

- 5. Select **Lightbar Auxiliary** functions for the button. For a description of the functions, see the table on page 42.



- 6. Verify your button settings in the **Button Configuration Module**.

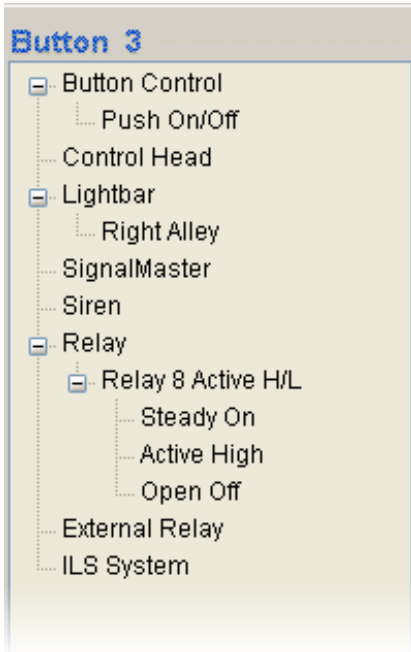

- 7. When you are finished, press **CTRL + S**, or select **Save** or **Save As** from the **File** menu, and save the configuration file in the folder you created on your hard drive.

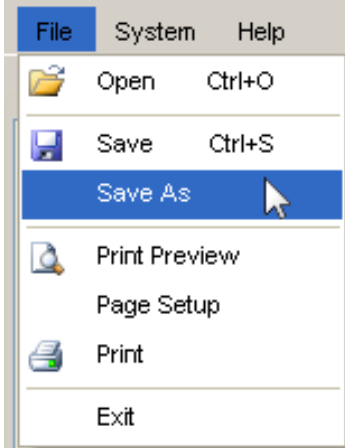

Pop-Up Message: "Overwriting the Default Configuration"

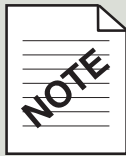

When you select **Save** for the first time, the message "Trying to overwrite protected default configuration" appears. Click **OK**. In the **Save As** dialog box, navigate to the folder you created for your configuration files and save the file under a new name. When you click **Save** again before closing the application, it updates your renamed file by overwriting it.

Linking Buttons to Slide Switch Positions (Lightbar Pane)

Buttons 1 to 5 and **Buttons 14 and 15** can be programmed to activate when the operator puts the slide switch into a position linked to one or more of these buttons. This feature enables the operator to turn functions on and off without changing the position of the slide switch. Linking a button also extends the number of assignable functions available to a slide switch button with the additional 10 functions of the linked button.

To link a button for activation by a slide switch position:

1. Click a **Slide Switch Button**.



2. If the lightbar pane is not in front of the other **Device Selection** panes, click the **Lightbar** tab.

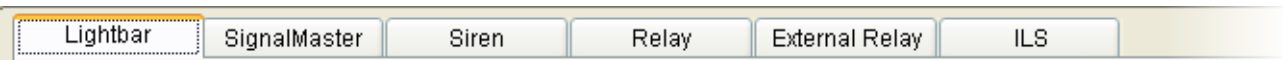

Note: The Button Control Module is unavailable for assignment because each position acts as a momentary switch that turns on and off devices assigned to them. To program the slide switch to operate as a progressive switch, assign the same functions from the previous slide switch position to the next position, then add new functions. Up to ten functions can be assigned directly to **Slide Switch 1** and **2**, and up to twenty to **Slide Switch 3**.

3. Click the arrow next to the drop-down list of 30 flash patterns. Move your cursor over a pattern to highlight and select it. The SmartSiren Platinum Siren Amplifier mimics the corresponding flash pattern number available in the lightbar model on the Convergence Network.



The flash patterns are classified as either **Lightbar** for the **Slide Switch** buttons or **Intersection** for all other buttons except **SignalMaster** and **Warn**. They are the same patterns; the different classification emphasizes how they are used. The intersection pattern is typically a high activity pattern that is assigned to a **Timer** button with an eight second duration.

Available flash patterns

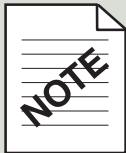

Some lightbars have fewer or more flash patterns than are available in the drop-down list. Lightbars that have fewer patterns are restricted to the last pattern available in the pattern library within the lightbar. Lightbars that have more patterns are restricted to the number available in the drop-down list.

For more information about flash patterns, consult the instruction manual for your model of lightbar.

Configuring the Lightbar

4. Select **Lightbar Auxiliary** functions for the button. For a description of the functions, see the table on page 42.
5. Click a button to activate it (green) in the selected slide switch position. Select additional buttons if you want to turn on or off their assigned functions along with the function assigned to the slide switch position.



6. Verify your button settings in the **Button Configuration Module**. The buttons activated by the slide switch position is listed under **Control Head** in the directory tree.

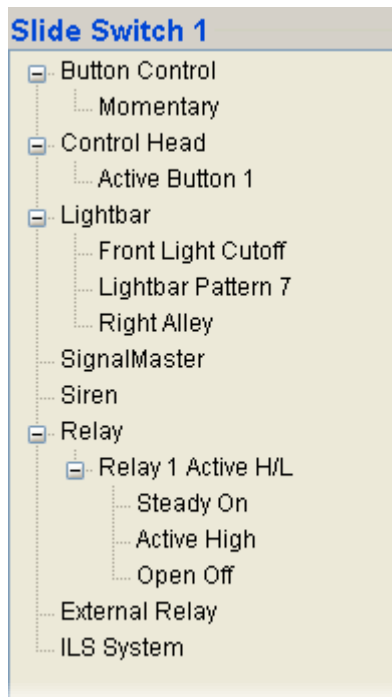

Configuring the Lightbar

- When you are finished, press **CTRL + S**, or select **Save** or **Save As** from the **File** menu, and save the configuration file in the folder you created on your hard drive.

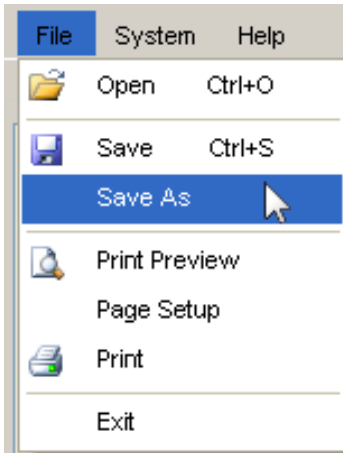

Pop-Up Message: "Overwriting the Default Configuration"

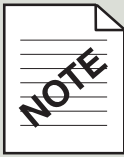

When you select **Save** for the first time, the message "Trying to overwrite protected default configuration" appears. Click **OK**. In the **Save As** dialog box, navigate to the folder you created for your configuration files and save the file under a new name. When you click **Save** again before closing the application, it updates your renamed file by overwriting it.

Lightbar Auxiliary Functions

Function	Description
<input type="checkbox"/> Right Alley	White light directed to the right side of the vehicle.
<input type="checkbox"/> Left Alley	White light directed to the left side of the vehicle.
<input type="checkbox"/> Work Light	White light directed to the rear of the vehicle.
<input type="checkbox"/> Steady Burn	One or more lights that stay on and do not flash.
<input type="checkbox"/> Front Light Cutoff	Turns off light on the front of the lightbar.
<input type="checkbox"/> Rear Light Cutoff	Turns off light on the rear of the lightbar.
<input type="checkbox"/> White Light Cutoff	Turns off all white lights: alley, takedown, work lights, scene, and cruise lights.
<input type="checkbox"/> Takedowns	White light directed to the front of the vehicle.
<input type="checkbox"/> Flash Takedown/Alley	Flashes the takedown and alley lights.
<input type="checkbox"/> Scene Light	White lights typically used in pairs to illuminate the work areas around the perimeter of the vehicle.
<input type="checkbox"/> Scene Right	Scene light on the front right of the lightbar
<input type="checkbox"/> Scene Left	Scene light on the front left of the lightbar
<input type="checkbox"/> Dimming	Dims the lights approximately 50 percent to prevent blinding approaching drivers at night.
<input type="checkbox"/> Cruise Light	The outer ends of the lightbar dim to eliminate the disorienting effect of flashing lights.

continued on next page

Lightbar Auxiliary Functions (continued)

Function

Description

Jog Right (Vision SLR)

Takedown LED pods rotate to the right 1.875 degrees (192 steps) with each press of the control pad button assigned to the function. To rotate the takedowns to a position, press and hold the control pad button. Release the button when the pod reaches the position you want.

Alley LED pod moves backward with a press of the control pad button assigned to the function.

Jog Left (Vision SLR)

Takedown LED pods rotate to the right 1.875 degrees (192 steps) with each press of the control pad button assigned to the function. To rotate the takedowns to a position, press and hold the control pad button. Release the button when the pod reaches the position you want.

Alley LED pod moves forward with a press of the control pad button assigned to the function.

CHAPTER 5

Configuring the SignalMaster

An Overview of the SignalMaster Pane

The **SignalMaster** Pane has seven types of SignalMaster lightbars of which a maximum of four can be assigned to the network. The button you select determines which of four SignalMaster panes opens on your desktop. The **SignalMaster** and **Warn** buttons are dedicated only to SignalMaster lights.

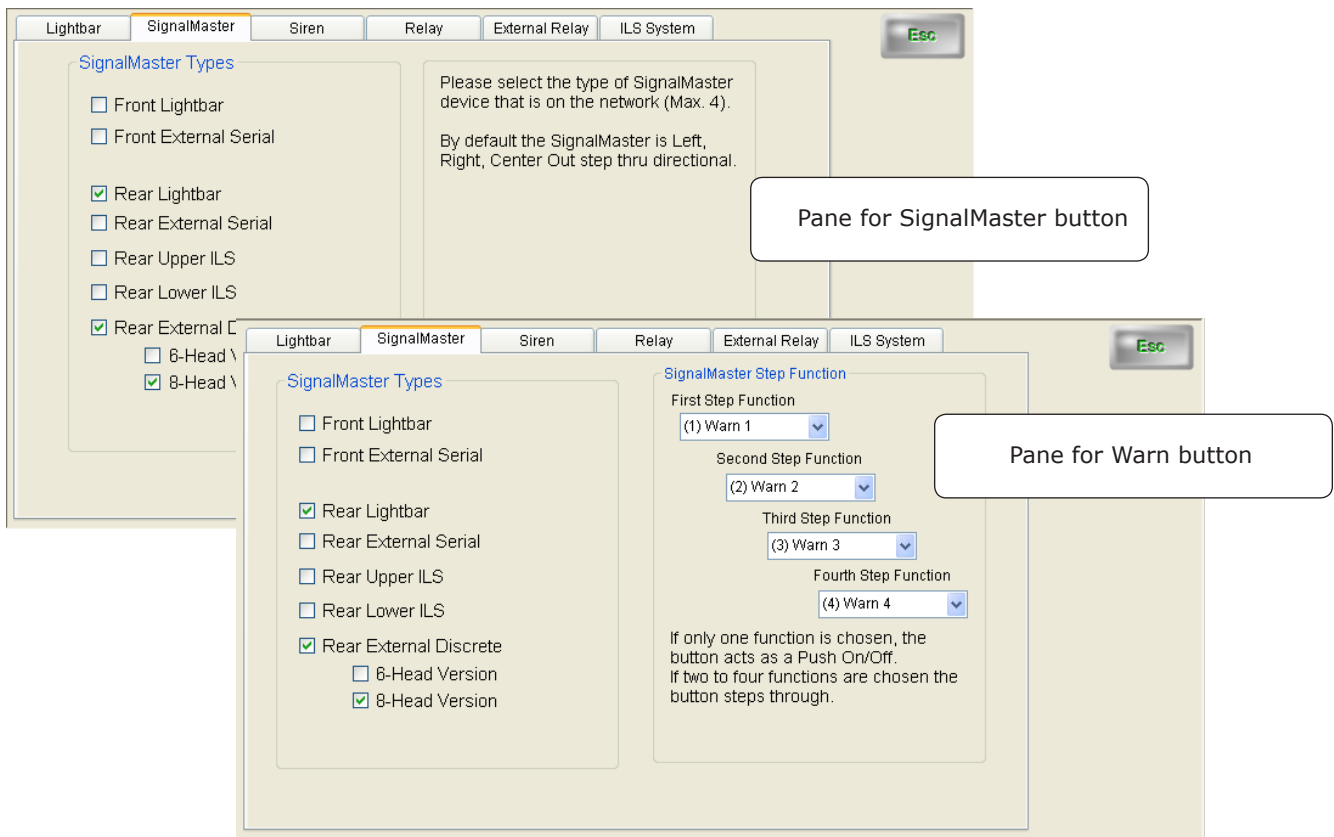

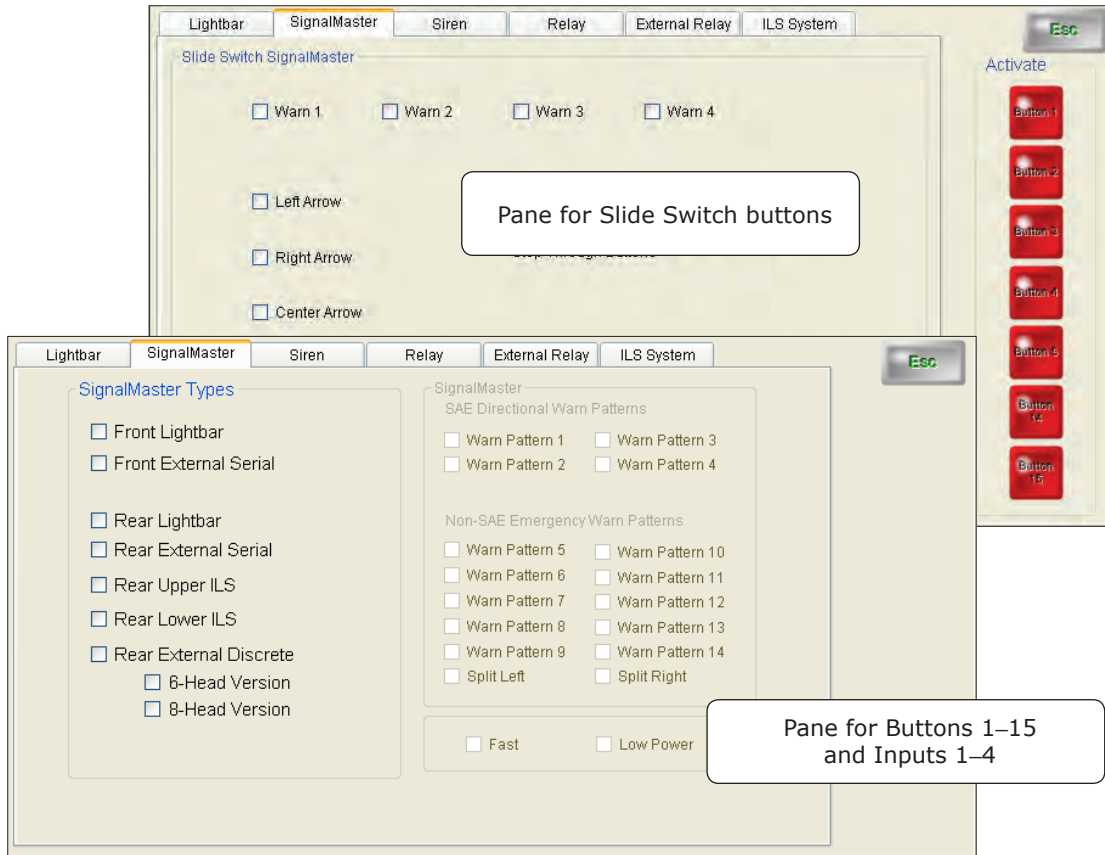

SignalMaster lights build directional patterns by sequentially activating six or eight amber light heads. Each lamp remains lit until the pattern is completed. SignalMaster lights also flash up to 14 different warn patterns.

SignalMaster types are either standalone lightbars or are integrated into the front or rear of a full-featured Federal Signal lightbar. Lightbar models include the Arjent S2, Legend, Raydian S2, Valor, and Vision SLR. When part of a full-featured lightbar, SignalMaster light heads can be any color, except when they also serve as Stop/Turn/Tail LEDs, Worklights, and Takedown lights.

SignalMaster Default Settings

Before you begin, you may want to review these SignalMaster default settings. For an keypad view of the default settings, see the table in the appendix on page 115.

Button	Button Control*	Signal Type	Pattern
SignalMaster	Momentary	Rear Lightbar Rear External Discrete, 8-Head Version	Step-Through selection of Left, Right, Center Out patterns (not configurable)
Warn	Momentary	Rear Lightbar. Rear External Discrete, 8-Head Version	Step-through warning Patterns 1 through 4

* The **Button Control Module** is not available because the option cannot be changed.

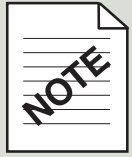

Verify features before configuring the lightbar

Federal Signal ILS lightbars may not have all the features available in the lightbar pane. To make the software configuration of the control pad quick and accurate, determine what hardware features and DIP switch settings are in the lightbar before you begin. Refer to "Setting Configuration Options" for the Rear ILS lightbar in Doc. No. 2562422 and "Setting Configuration Options" for the Front ILS lightbar in Doc. No. 2562423.

Assigning SignalMaster Control to the SignalMaster Button

When you click the **SignalMaster** button, a SignalMaster pane with default step-through SAE directional patterns appears in the **Device Selection Module**. Select up to four networked SignalMaster types and the application takes care of assigning the directional patterns for you, in which each press of the button steps through a selection of Left, Right, Center Out.

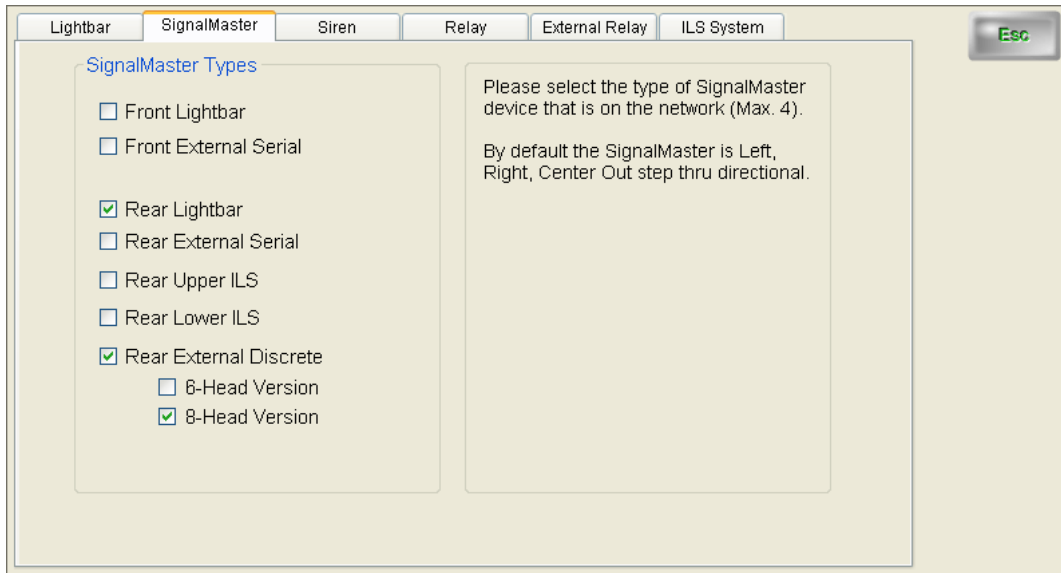

To assign SignalMaster control to the **SignalMaster** button.

1. Click the **SignalMaster** button. The **SignalMaster** pane moves to the front.



2. Select the types of SignalMaster installed in the vehicle. Up to four different types can be assigned to the Convergence Network. The types are described in the table on page 57.

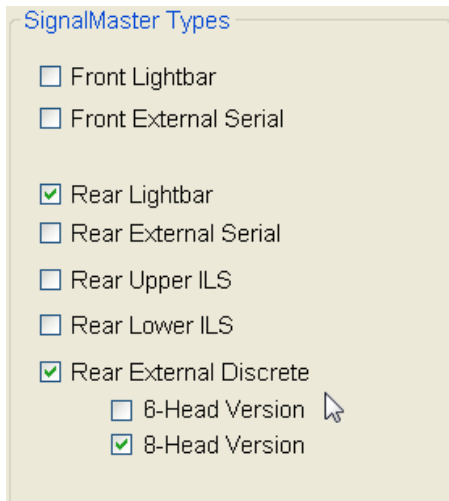

3. Verify your button settings in the **Button Configuration Module**.

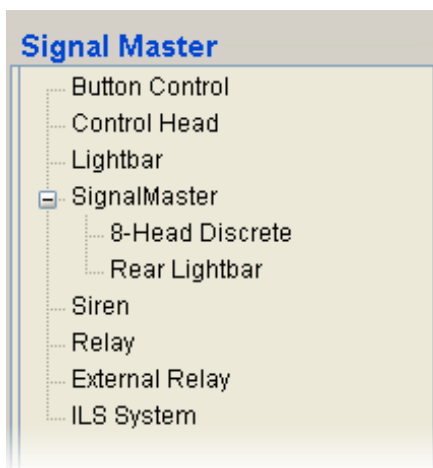

4. When you are finished, press **CTRL + S**, or select **Save** or **Save As** from the **File** menu, and save the configuration file in the folder you created on your hard drive.

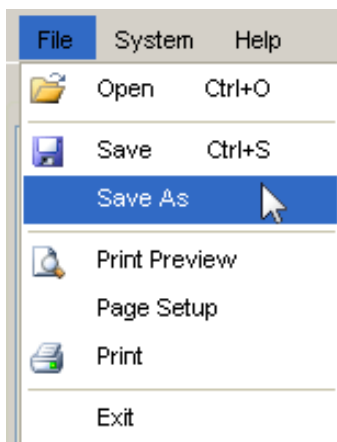

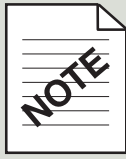

Pop-Up Message: "Overwriting the Default Configuration"

When you select **Save** for the first time, the message "Trying to overwrite protected default configuration" appears. Click **OK**. In the **Save As** dialog box, navigate to the folder you created for your configuration files and save the file under a new name. When you click **Save** again before closing the application, it updates your renamed file by overwriting it.

Assigning SignalMaster Control to the Warn Button

When you select the **Warn** button, a SignalMaster pane appears in the **Device Selection Module** with four step functions, each with 14 selectable warning patterns. SAE directional warn patterns are **Warn Patterns 1** through **4**. Non-SAE Emergency Warn Patterns are **Warn Patterns 5** through **14**.

Buttons 1 to **5** and **Buttons 14** and **15** can be programmed to activate when the operator puts the slide switch into a position linked to one or more of these buttons. This feature enables the operator to turn selected directional patterns on and off or skip steps in selecting a step-through SignalMaster warn or directional pattern without changing the position of the slide switch. See "Assigning SignalMaster Control to the Slide Switch" on page 54.

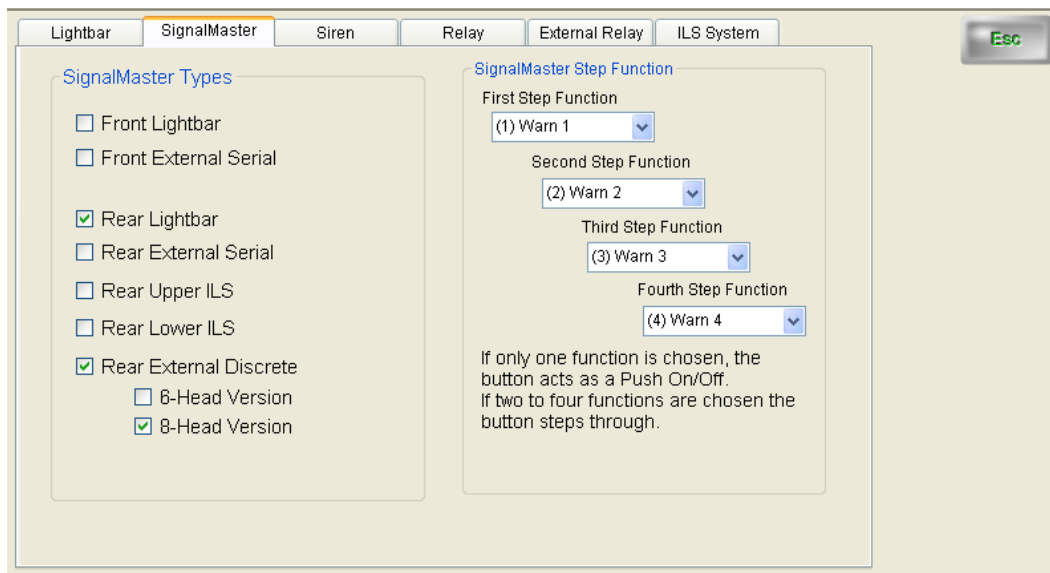

To assign a Signalmaster function to the **Warn** button:

1. Click the **Warn** button. The **SignalMaster** pane moves to the front.



Configuring the SignalMaster

2. Select the types of SignalMaster lights installed in the vehicle. Up to four different types can be assigned to the Convergence Network. They are described in the table on page 57.

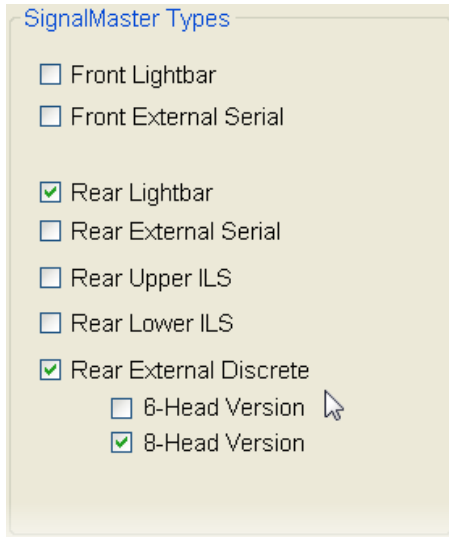

SignalMaster Types

- Front Lightbar
- Front External Serial
- Rear Lightbar
- Rear External Serial
- Rear Upper ILS
- Rear Lower ILS
- Rear External Discrete
 - 6-Head Version
 - 8-Head Version

3. To select Warn Pattern step functions, click the arrow next to the drop-down list. Move your cursor over a pattern to highlight and select it. If you assign only one step function, the button acts as a push on/off button. If you assign more than one step function, each press of the button steps through an assigned pattern. A press of the button after the last assigned step function turns off the button.

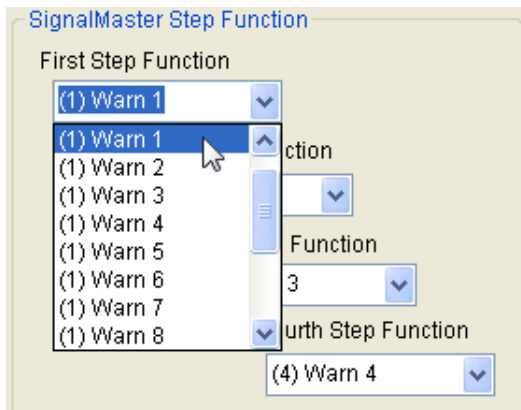

SignalMaster Step Function

First Step Function

(1) Warn 1

(1) Warn 1

(1) Warn 2

(1) Warn 3

(1) Warn 4

(1) Warn 5

(1) Warn 6

(1) Warn 7

(1) Warn 8

Function

3

Fourth Step Function

(4) Warn 4

4. Verify your settings in the **Button Configuration Module**.

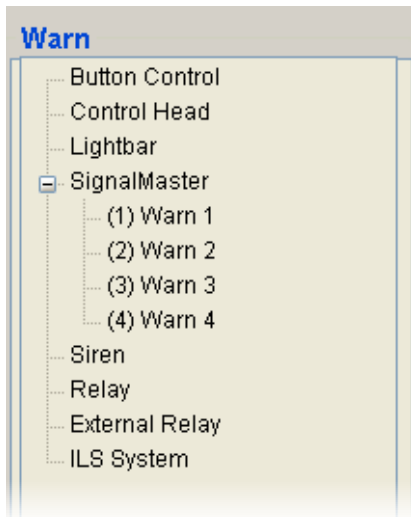

5. When you are finished, press **CTRL + S**, or select **Save** or **Save As** from the **File** menu, and save the configuration file in the folder you created on your hard drive.

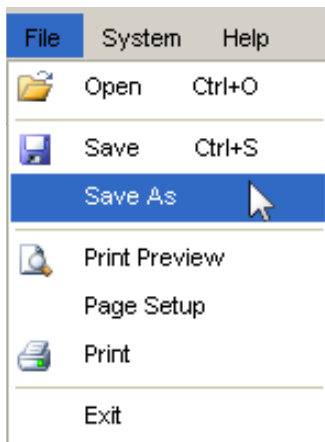

Pop-Up Message: "Overwriting the Default Configuration"

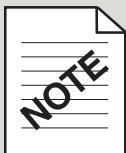

When you select **Save** for the first time, the message "Trying to overwrite protected default configuration" appears. Click **OK**. In the **Save As** dialog box, navigate to the folder you created for your configuration files and save the file under a new name. When you click **Save** again before closing the application, it updates your renamed file by overwriting it.

Assigning SignalMaster Control to Buttons 1 to 15 and Inputs

If you select **Buttons 1 to 15** and the **Input Buttons** a pane appears with 16 different warn patterns, including **Split Left** and **Split Right**, and the options to increase build speed or dim the lights. For a description of **Fast** and **Low Power**, see the table "Fast and Low Power Options" on page 58.

To assign a SignalMaster function to a button:

1. Click the any button except **SignalMaster** and **Warn**.

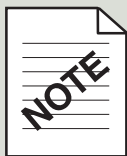

Button Function Limits

The selections for all buttons (except **Slide Switch 3**, which accepts a limit of 20) are limited to a maximum of 10.

2. Select how you want the button to operate by clicking an option button in the **Button Control** pane. If you want the button to act as a timer, select the duration from the drop-down list.

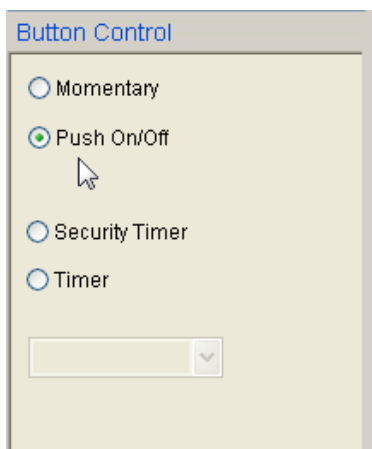

3. If the lightbar pane is not in front of the other **Device Selection** panes, click the **Lightbar** tab.

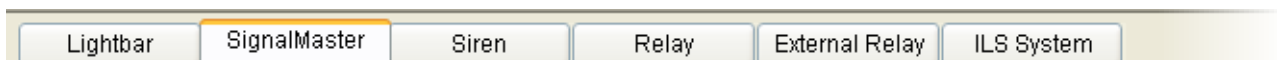

Configuring the SignalMaster

4. Select the types of SignalMaster installed in the vehicle. Up to four different types can be assigned to the Convergence Network. They are described in the table on page 57.

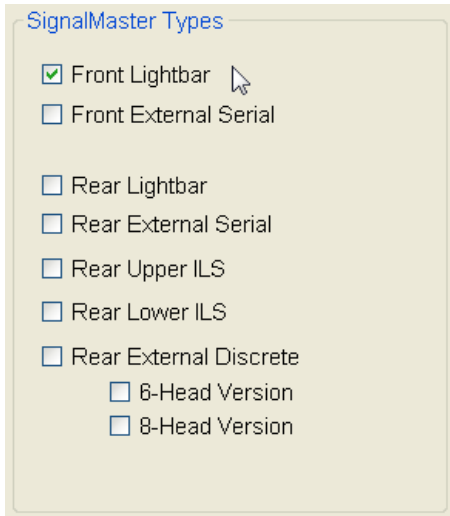

SignalMaster Types

- Front Lightbar
- Front External Serial

- Rear Lightbar
- Rear External Serial
- Rear Upper ILS
- Rear Lower ILS
- Rear External Discrete
 - 8-Head Version
 - 8-Head Version

5. Select one warn pattern. When the button is pressed, each selected **SignalMaster Type** displays the pattern. **Split Left** and **Split Right** are not available for **Front** SignalMaster types.

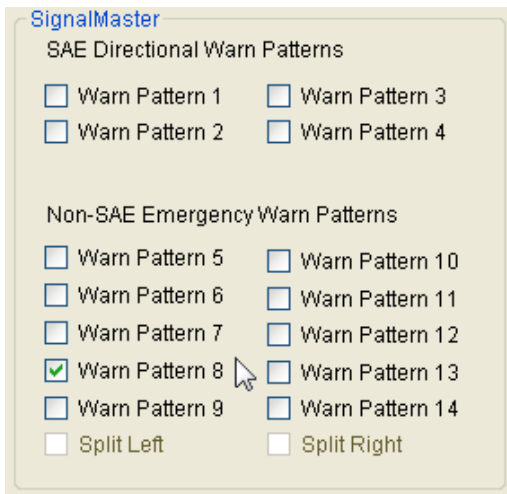

SignalMaster

SAE Directional Warn Patterns

- Warn Pattern 1
- Warn Pattern 2
- Warn Pattern 3
- Warn Pattern 4

Non-SAE Emergency Warn Patterns

- Warn Pattern 5
- Warn Pattern 6
- Warn Pattern 7
- Warn Pattern 8
- Warn Pattern 9
- Warn Pattern 10
- Warn Pattern 11
- Warn Pattern 12
- Warn Pattern 13
- Warn Pattern 14
- Split Left
- Split Right

6. Select **Fast** or **Low Power**, or both. See the table "Fast and Low Power Options" on page 58.

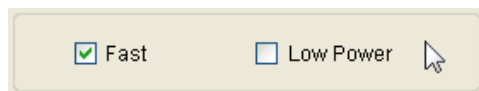

Fast

Low Power

7. Verify your settings in the **Button Configuration Module**.

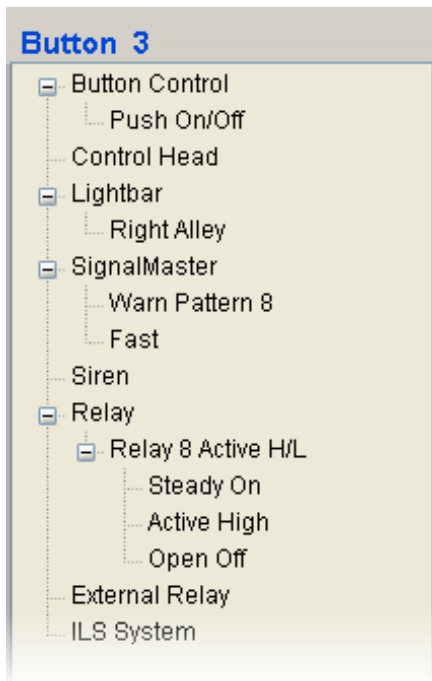

8. When you are finished, press **CTRL + S**, or select **Save** or **Save As** from the **File** menu, and save the configuration file in the folder you created on your hard drive.

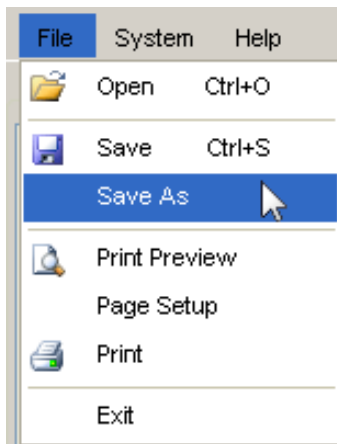

Pop-Up Message: "Overwriting the Default Configuration"

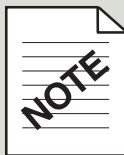

When you select **Save** for the first time, the message "Trying to overwrite protected default configuration" appears. Click **OK**. In the **Save As** dialog box, navigate to the folder you created for your configuration files and save the file under a new name. When you click **Save** again before closing the application, it updates your renamed file by overwriting it.

Assigning SignalMaster Control to the Slide Switch

When you click a **Slide Switch** button, a **SignalMaster** pane appears with selections associated with the **SignalMaster** and **Warn** buttons. See "Assigning SignalMaster Control to the SignalMaster Button" on page 46 and "Assigning SignalMaster Control to the Warn Button" on page 48).

Warn 1 (First Step Function) through **Warn 4** (Fourth Step Function) enable you to link the **Warn** patterns you selected in the SignalMaster pane for the **Warn** button to a **Slide Switch Button**.

Left Arrow, **Right Arrow**, and **Center Out** enable you to link any of the three directional patterns associated with the **SignalMaster** button to a **Slide Switch Button**.

The button associated with a slide switch position activates when the operator puts the slide switch into a position linked to the button. This feature enables the operator to turn patterns on and off or skip steps in selecting a step-through SignalMaster warn or directional pattern without changing the position of the slide switch. Linking a button also extends the number of assignable functions available to a slide switch button with the additional 10 functions of the linked button.

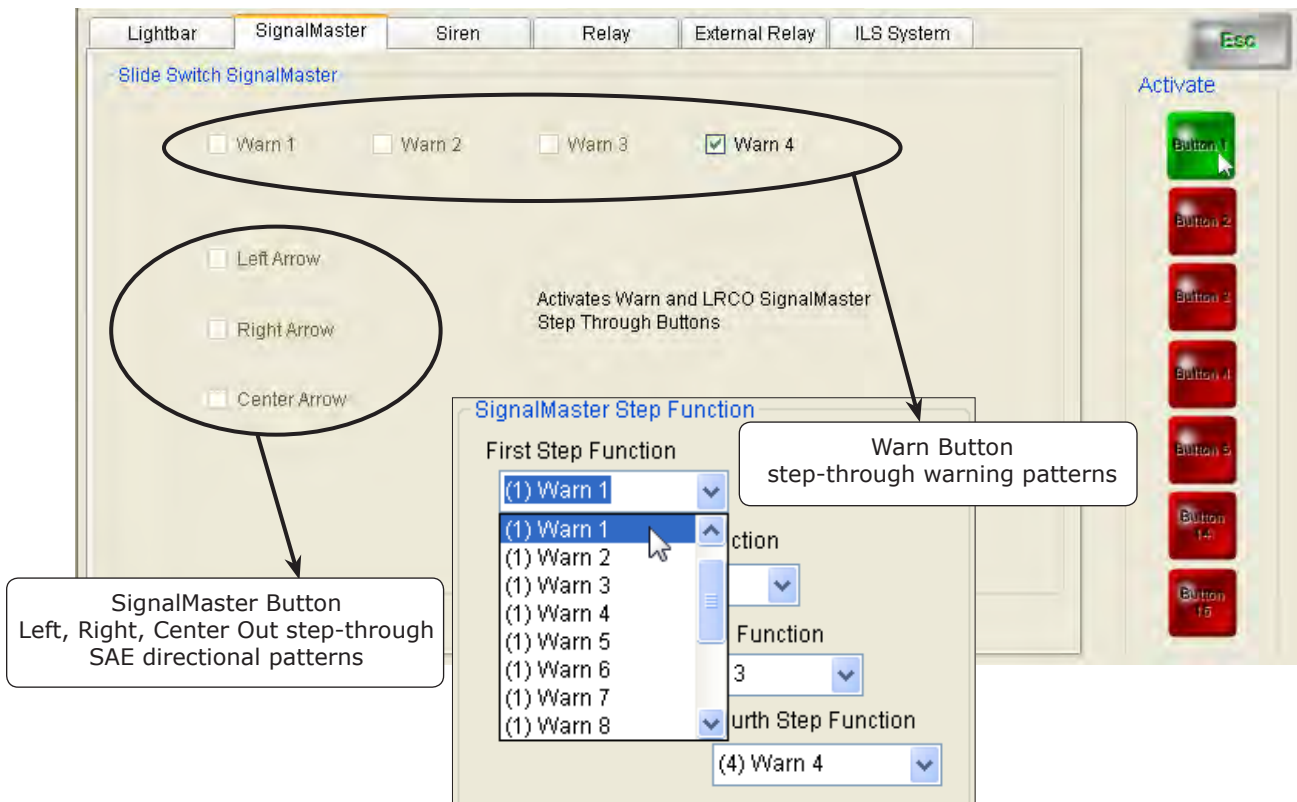

To link a button for activating a warning or directional pattern:

1. Click a **Slide Switch Button**.



2. Select a SignalMaster step function (with its associated warn pattern) and assign it to the button you want activated. In the example below, **Button 1**, activated by **Slide Switch Position 1**, turns on the warn pattern assigned to the **Fourth Step Function**, which is the fourth push of the **Warn Button**.



3. To continue, click another **Slide Switch Button**, select a function, and click another button (**Buttons 1 to 5** and **Buttons 14** and **15**) to activate.

- When you are finished, verify your settings in the **Button Configuration Module**. The activated **Button 1** is listed under **Control Head** in the directory tree. The **SignalMaster Step Function** assigned to **Button 1** is the warn pattern assigned to the **Fourth Step** (fourth press) of the **Warn Button**.

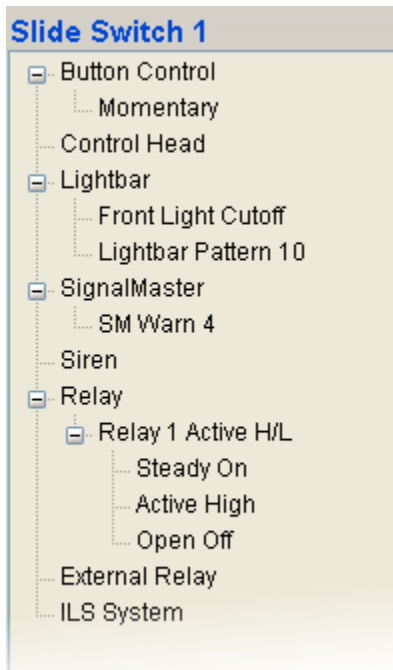

- When you are finished, press **CTRL + S**, or select **Save** or **Save As** from the **File** menu, and save the configuration file in the folder you created on your hard drive.

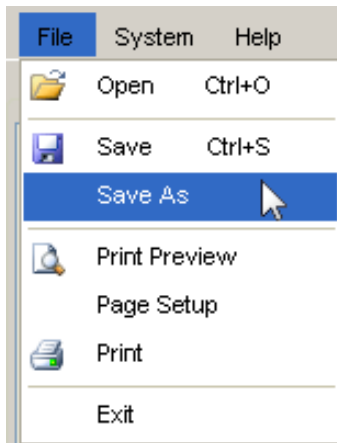

Pop-Up Message: "Overwriting the Default Configuration"

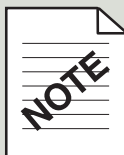

When you select **Save** for the first time, the message "Trying to overwrite protected default configuration" appears. Click **OK**. In the **Save As** dialog box, navigate to the folder you created for your configuration files and save the file under a new name. When you click **Save** again before closing the application, it updates your renamed file by overwriting it.

SignalMaster Types

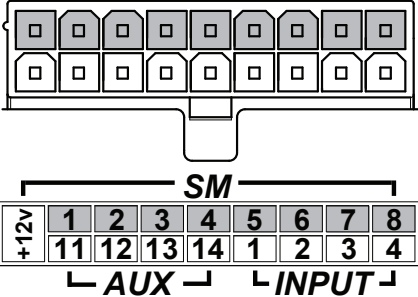
Function	Description
<input type="checkbox"/> Front Lightbar	Six or eight SignalMaster light heads that are built into the front of a serially-controlled Federal Signal lightbar.
<input type="checkbox"/> Rear External Serial	A standalone serially-controlled SignalMaster that is mounted on the exterior of the vehicle facing the front. The lightbar is connected to a serial port on the SmartSiren Platinum Siren Amplifier through a RS-485 cable.
<input type="checkbox"/> Rear Lightbar	Six or eight SignalMaster light heads that are built into the rear of a serially-controlled Federal Signal lightbar.
<input type="checkbox"/> Rear External Serial	A standalone serially-controlled SignalMaster lightbar that is mounted on the exterior of the vehicle facing the rear. The lightbar is connected to a serial port on the SmartSiren Platinum Siren Amplifier through an RS-485 cable.
<input type="checkbox"/> Rear Upper ILS	A standalone Solaris ILS SignalMaster lightbar that is mounted on the inside of the upper rear windshield. The lightbar is connected to a serial port on the SmartSiren Platinum Siren Amplifier through an RS-485 cable.
<input type="checkbox"/> Rear Lower ILS	A standalone Solaris ILS SignalMaster lightbar that is mounted on the inside of the lower rear windshield. The lightbar is connected to a serial port on the SmartSiren Platinum Siren Amplifier through an RS-485 cable.
<input type="checkbox"/> Rear External Discrete <input type="checkbox"/> 6-Head Version <input type="checkbox"/> 8-Head Version	<p>A non-serially-controlled standalone SignalMaster lightbar that is mounted facing the rear of the vehicle.</p> <p>The 6-Head Version has wires that connect to SM pins 2 through 7 on the SmartSiren Platinum Siren Amplifier.</p> <p>The 8-Head Version has wires that connect to SM pins 1 through 8 on the SmartSiren Platinum Siren Amplifier.</p> 

SignalMaster ILS Directional Patterns

Function	Description
<input type="checkbox"/> Split Left	Only available with the Rear ILS and Rear External Discrete (standalone) SignalMaster. Displays a chasing pattern from the center of the SignalMaster to the left, directing traffic to proceed around the vehicle to the left.
<input type="checkbox"/> Split Right	Only available with the Rear ILS and Rear External Discrete (standalone) SignalMaster. Displays a chasing pattern from the center of the SignalMaster to the right, directing traffic to proceed around the vehicle to the right.

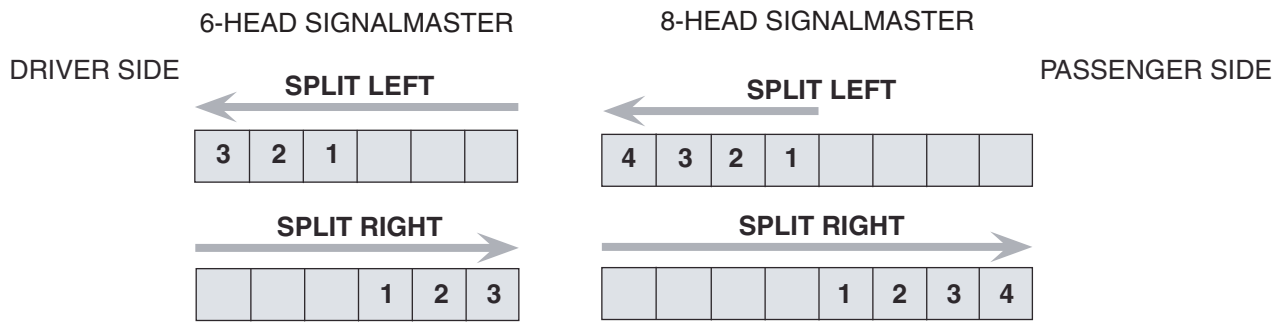

Fast and Low Power Options

Function	Description
<input type="checkbox"/> Fast	Increases the build speed and the urgency of the warning pattern.
<input type="checkbox"/> Low Power	To decrease power consumption and for nighttime operation, low-power mode turns on a single lamp at a time, instead of building the pattern. The feature is available only with the Rear External Discrete SignalMaster.

CHAPTER 6

Configuring the Siren

An Overview of the Siren Pane

The button you select determines which of four **Siren** panes opens on your desktop. The sections that follow describe the functions that are available depending on the button selected.

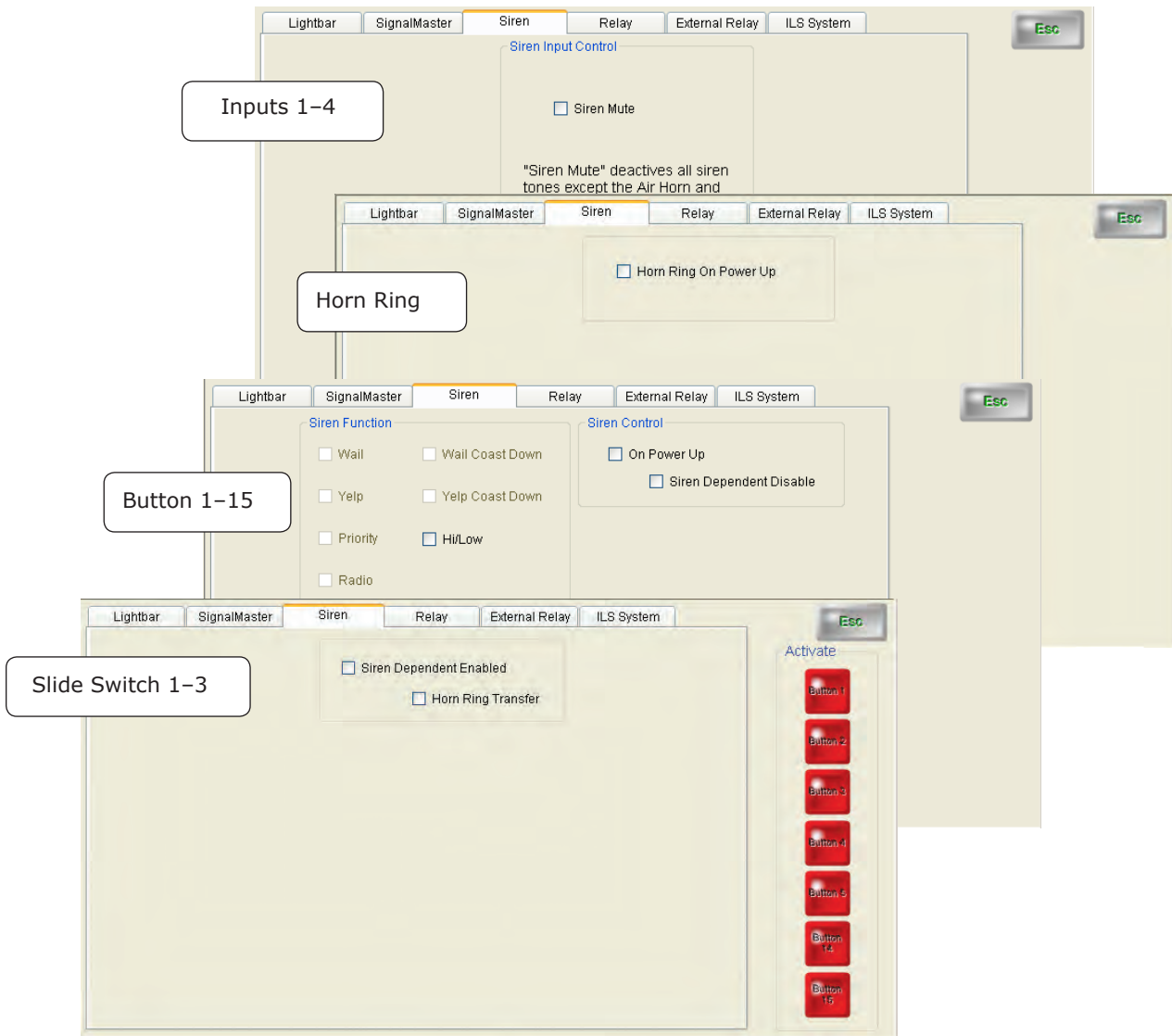

Siren Default Settings

Before you begin, you may want to review these siren default settings. For an keypad view of the default settings, see the table in the appendix on page 115.

Button	Siren Function	Button Control	Activated Button
Button 6	Siren: Standby	Exclusive	
Button 7	Siren: Radio	Exclusive	
Button 9	Siren: Wail	Exclusive	
Button 10	Siren: Yelp	Exclusive	
Button 11	Siren: Priority	Exclusive	
Button 12	Siren: Manual	Momentary	
Button 13	Siren: Air Horn	Momentary	
Slide Switch 1	Horn Ring Transfer	Momentary*	Button 1
Slide Switch 2	Horn Ring Transfer	Momentary*	
Slide Switch 3	Siren Dependent Enabled Horn Ring Transfer	Momentary*	
Inputs 1 through 4		Momentary	

* The **Button Control Module** is not available because the option cannot be changed

Assigning Siren Functions to Buttons 1–15

The **Siren** Pane for **Buttons 1–15** and the **Horn Ring** button has a variety of siren functions, including eight siren tones, an electronic air horn, radio rebroadcast, and public address. Two functions for activating siren tones are also available.

NOTE: The **Standby** siren function, which turns off all siren tones, except **Air Horn** and **Manual**, is available with **Buttons 1** and **6**.

To assign a siren function to a button:

1. Click the a button in the range of **1** through **15**.



2. Select how you want the button to operate by clicking an option button in the **Button Control** pane. If you want the button to act as a timer, select the duration from the drop-down list. Some buttons have the **Button Control** option to be **Exclusive**. They turn on a function when pressed and turn off the button that was pressed previously in the same row.

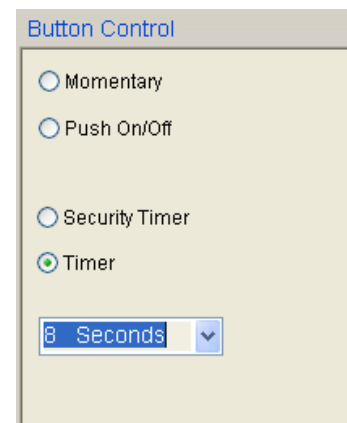

Configuring the Siren

3. If the **Siren** pane is not in front of the other **Device Selection** panes, click the **Siren** tab.

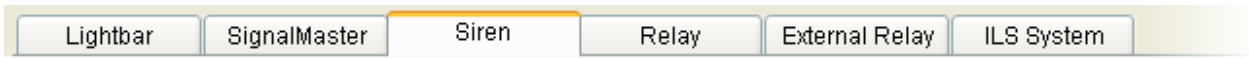

4. Select a **Siren Function**. A function is dimmed because it is assigned to other buttons. For a description of the functions, see the table "Siren Function (Buttons 1–15)" on page 69.

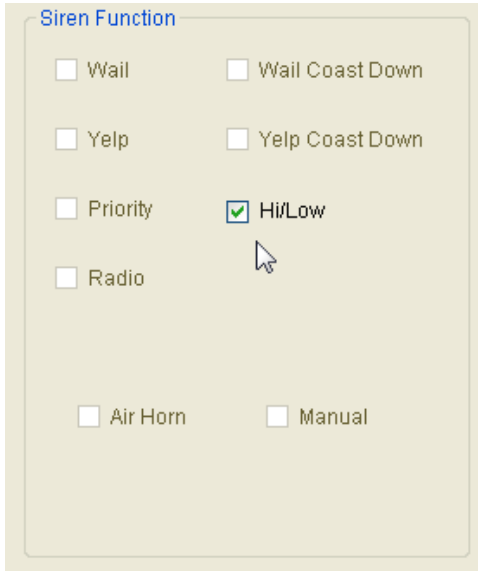

5. Select how the siren is controlled by the button. A function is dimmed because it is assigned to other buttons. For a description of the **Siren Control** options, see "Siren Control (Horn Ring)" and "Siren Control (Buttons 1–15)" on page 69.

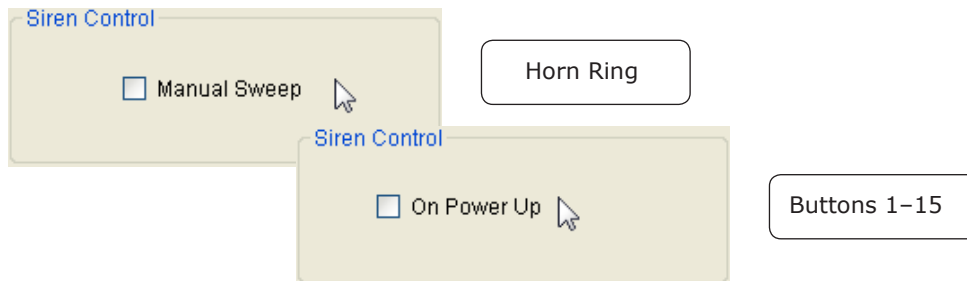

- Verify your settings in the **Button Configuration Module**.

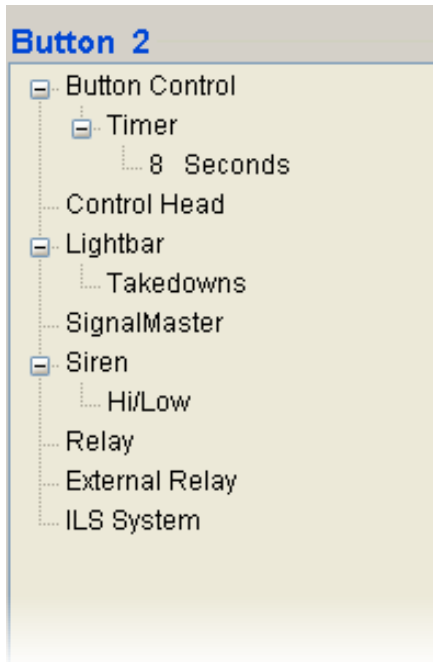

- When you are finished, press **CTRL + S**, or select **Save** or **Save As** from the **File** menu, and save the configuration file in the folder you created on your hard drive.

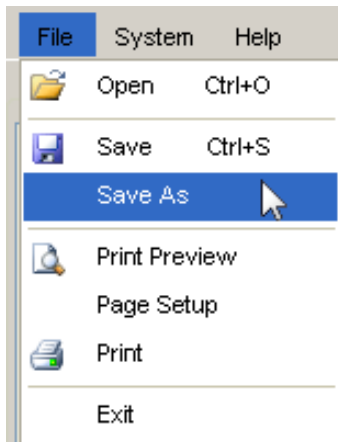

Pop-Up Message: "Overwriting the Default Configuration"

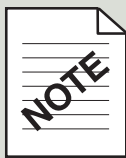

When you select **Save** for the first time, the message "Trying to overwrite protected default configuration" appears. Click **OK**. In the **Save As** dialog box, navigate to the folder you created for your configuration files and save the file under a new name. When you click **Save** again before closing the application, it updates your renamed file by overwriting it.

Assigning Siren Functions to Slide Switch 1–3

The control of siren tones, rather than the tones themselves, are selectable functions for the **Slide Switch**. One option is **Siren Dependent Enabled**, which restricts siren activation to the slide switch position you select. For example, if you press a button that is assigned a siren tone, the tone only activates when you place the slide switch in the position that is **Siren Dependent Enabled**.

The **Horn Ring Transfer** option enables the driver to step through each **Siren Function** assigned to the **Horn Ring** in the **Button Configuration Module** with each press of the horn button on the steering wheel. Functions can include siren tones, such as **Yelp** and **Wail**, **Radio** rebroadcast through the siren speakers, and **Public Address**, which transmits the operator’s voice through the microphone to the siren speakers.

To assign siren functions to a slide switch button:

1. Click a **Slide Switch** button.

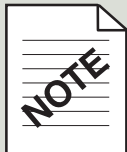

Button Function Limits

The functions for all buttons (except **Slide Switch 3**, which accepts a limit of 20) are limited to a maximum of 10.

2. If the **Siren** pane is not in front of the other **Device Selection** panes, click the **Siren** tab.

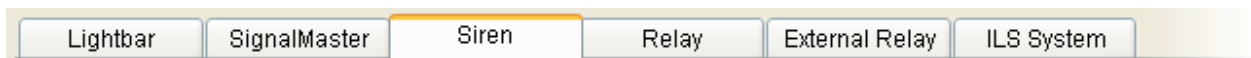

3. Select **Siren Dependent** or **Horn Ring Transfer** or both.

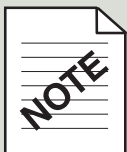
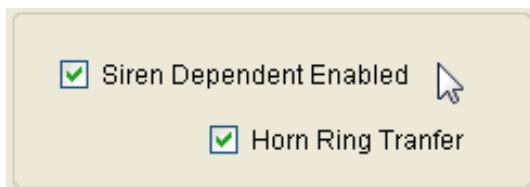

Button Control for the Slide Switch

The **Button Control Module** is unavailable for the **Slide Switch** because each switch position acts as a momentary button.

Configuring the Siren

- Click a button to activate it (green) in the selected slide switch position. Select additional buttons if you want to turn on or off their assigned functions along with the function assigned to the slide switch position.

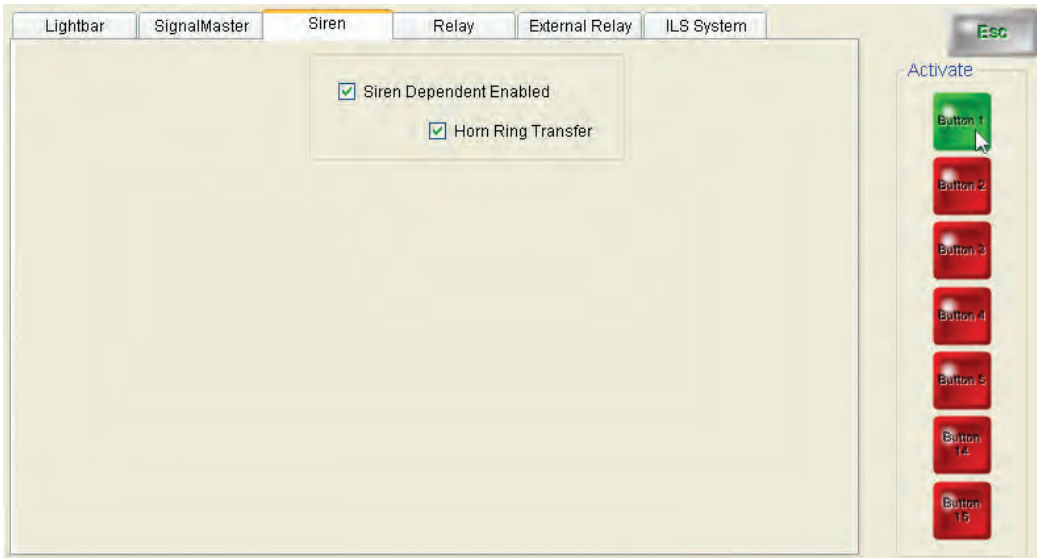

- Verify your settings in the **Button Configuration Module**.

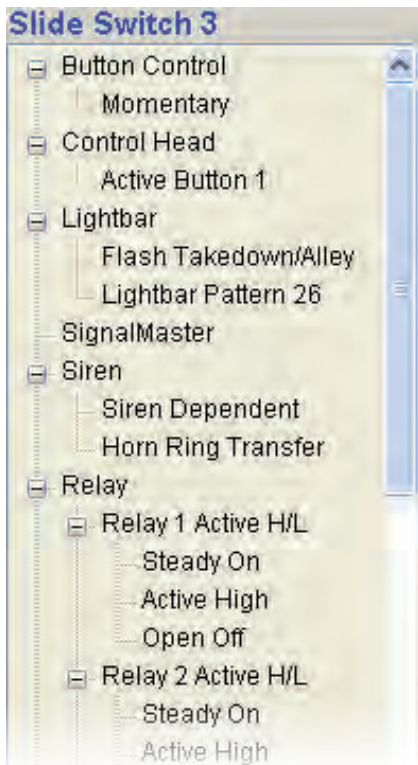

Configuring the Siren

- When you are finished, select **Save** or **Save As** from the **File** menu, and save the configuration file in the folder you created on your hard drive.

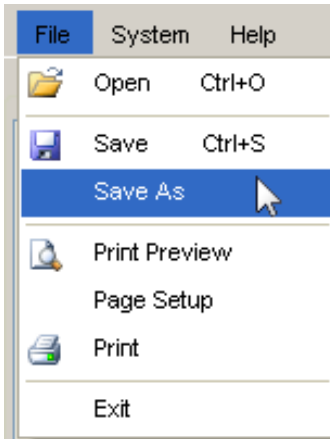

Pop-Up Message: "Overwriting the Default Configuration"

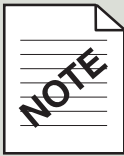

When you select **Save** for the first time, the message "Trying to overwrite protected default configuration" appears. Click **OK**. In the **Save As** dialog box, navigate to the folder you created for your configuration files and save the file under a new name. When you click **Save** again before closing the application, it updates your renamed file by overwriting it.

Assigning Siren Input Control to Inputs 1–4

The **Input** buttons are not part of the control pad. Instead, they are “virtual” buttons that represent switches (page 70) connected to the back of the SmartSiren Platinum Siren Amplifier (page 29). **Input 1** and **2** are active low inputs that activate when the input pin is pulled to ground. **Input 3** and **4** are active high inputs that activate when the input pin is pulled to 12 Vdc battery voltage.

Inputs 1–4 are most commonly used for circuits that send a signal to the SmartSiren Platinum system when a condition in the vehicle changes. Changes may include the opening of a trunk or door, a rise in vehicle temperature, or the release of a gun lock. The inputs are often used for police vehicle anti-theft devices, intrusion alarms, and temperature monitoring systems for K9 vehicles. Similarly, the **Park Detect** circuit sends a signal to the SmartSiren Platinum Siren Amplifier when the vehicle transmission is shifted to park or neutral.

The siren pane for the **Input** and **Park Detect** buttons has a **Siren Mute** function that you can select for each button. If the vehicle driver turns on a siren function, such as a siren tone or public address, by pressing a control pad button, **Siren Mute** automatically deactivates all siren functions, except for the **Air Horn** and **Manual** tones, when the **Input** and **Park Detect** circuits are active. Siren functions resume when the circuits are inactive.

To assign **Siren Input Control** to an **Input button** or the **Park Detect** button:

1. Click an **Input Button** or the **Park Detect** button.

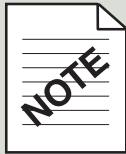

Button Function Limits

The functions for all buttons (except **Slide Switch 3**, which accepts a limit of 20) are limited to a maximum of 10.

2. If the siren pane is not in front of the other **Device Selection** panes, click the **Siren** tab.

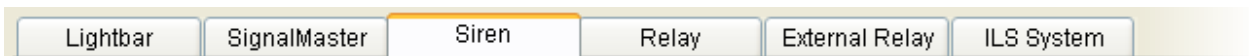

Configuring the Siren

3. Select how you want the **Input** circuits to operate. The module is not available for the **Park Detect** circuit because it operates as a momentary switch.

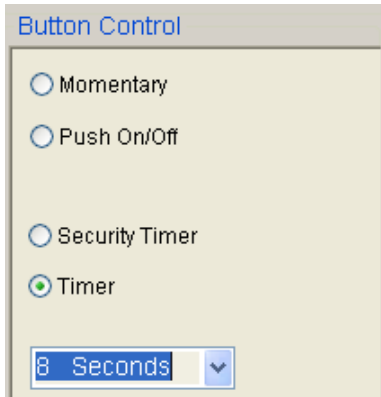

4. Select **Siren Mute** if you do not want siren tones to be audible when the input circuit is active or the vehicle transmission is in park or neutral.

Leave the checkbox empty or deselect **Siren Mute** if you want siren functions, such as **Public Address**, to be audible when the vehicle is parked or a siren tone to sound as an alarm when a condition in the vehicle changes.

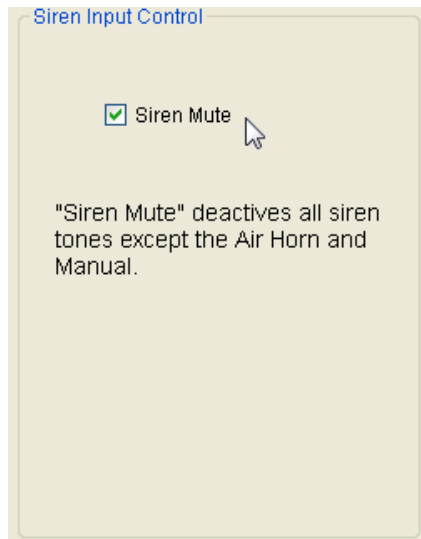

5. Verify your settings in the **Button Configuration Module**.

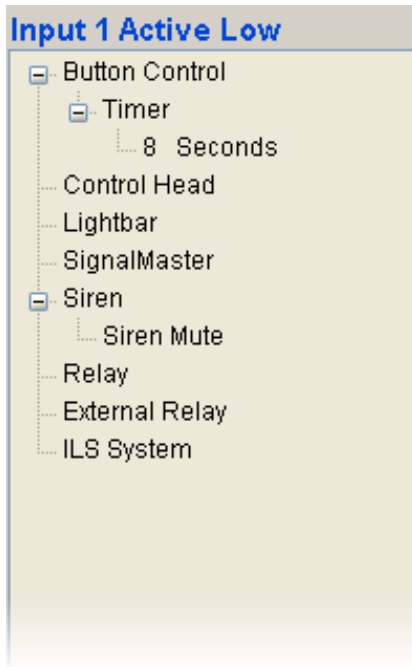

6. When you are finished, select **Save** or **Save As** from the **File** menu, and save the configuration file in the folder you created on your hard drive.

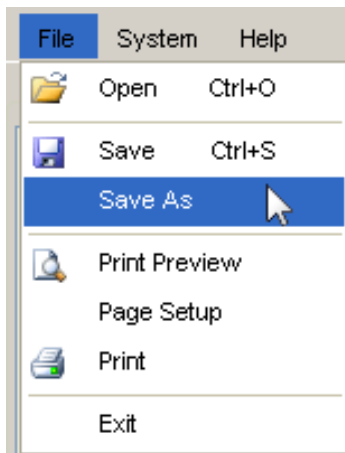

Pop-Up Message: "Overwriting the Default Configuration"

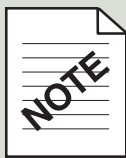

When you select **Save** for the first time, the message "Trying to overwrite protected default configuration" appears. Click **OK**. In the **Save As** dialog box, navigate to the folder you created for your configuration files and save the file under a new name. When you click **Save** again before closing the application, it updates your renamed file by overwriting it.

Siren Functions: Buttons 1–15

Function	Description
<input type="checkbox"/> Wail	Continuous wailing up-and-down tone.
<input type="checkbox"/> Wail Coast Down	Wail tone that falls in frequency after the tone is turned off.
<input type="checkbox"/> Yelp	Continuous rapid warbling tone.
<input type="checkbox"/> Yelp Coast Down	Rapid warbling tone that falls in frequency after the tone is turned off.
<input type="checkbox"/> Priority	Continuous rapid yelp tone.
<input type="checkbox"/> High/Low	Distinctive two-tone sound.
<input type="checkbox"/> Radio	Incoming radio messages are amplified by the siren and rebroadcast over the siren speaker.
<input type="checkbox"/> Standby	Turns off all siren tones, except Air Horn and Manual . Standby is available with Buttons 1 and 6 .
<input type="checkbox"/> Air Horn	A traffic-clearing loud blast of sound.
<input type="checkbox"/> Manual	Peak-and-wail tone.

Siren Control: Buttons 1–15

Function	Description
<input type="checkbox"/> On Power-Up	Each press of the horn button steps through a siren tone— Wail , then Yelp , and finally Priority —until the fourth press turns off the siren tone.
<input type="checkbox"/> Siren Dependent Disable	Turns off the Siren Dependent Enable , which restricts siren activation to a slide switch position.

Siren Control: Horn Ring

Function	Description
<input type="checkbox"/> Horn Ring On Power-Up	Turns on the Horn Ring Transfer function when the SmartSiren Platinum system is powered up.

Siren Control: Slide Switch 1–3

Function	Description
<input type="checkbox"/> Siren Dependent Enabled	Restricts siren activation to the slide switch position you select. For example, if you press a button that is assigned a siren tone, the tone only activates when you place the slide switch in the position that is Siren Dependent Enabled .
<input type="checkbox"/> Horn Ring Transfer	<p>Available when the horn detection circuit is connected either to pin 2 and pin 8 on the 12-pin connector on the rear of the SmartSiren Platinum Siren Amplifier or to pin 10 on the back of the control pad.</p> <p>The default setting for the slide switch is to transfer the horn ring activation of the siren in Slide Switch 2 and 3. Each press of the horn button on the steering wheel cycles through the Siren Function selected for the Horn Ring button. In addition, Slide Switch 2 is configured as Siren Dependent Enabled.</p>

Siren Control (Inputs 1–4)

Function	Description
<input type="checkbox"/> Siren Mute	When selected for an Input circuit, this function deactivates the all siren functions, except Air Horn and Manual , when the circuit is active.

1 AND 2
GROUND ACTIVE
(ACTIVE LOW)

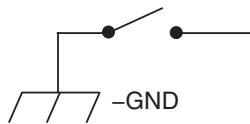

3 AND 4
+12 V ACTIVE
(ACTIVE HIGH)



CHAPTER 7

Configuring the Internal Relays

An Overview of the Internal Relays

The internal solid state relays in the **Relay Pane** connect to pins on the back of the SmartSiren Platinum Siren Amplifier (page 79). The ten 10-ampere relays can be configured as active high (pulled to 12 Vdc battery voltage) or active low (pulled to ground). The four three-ampere relays are active high only. The internal relays are commonly used for non-serial controlled devices or small flashing lights.

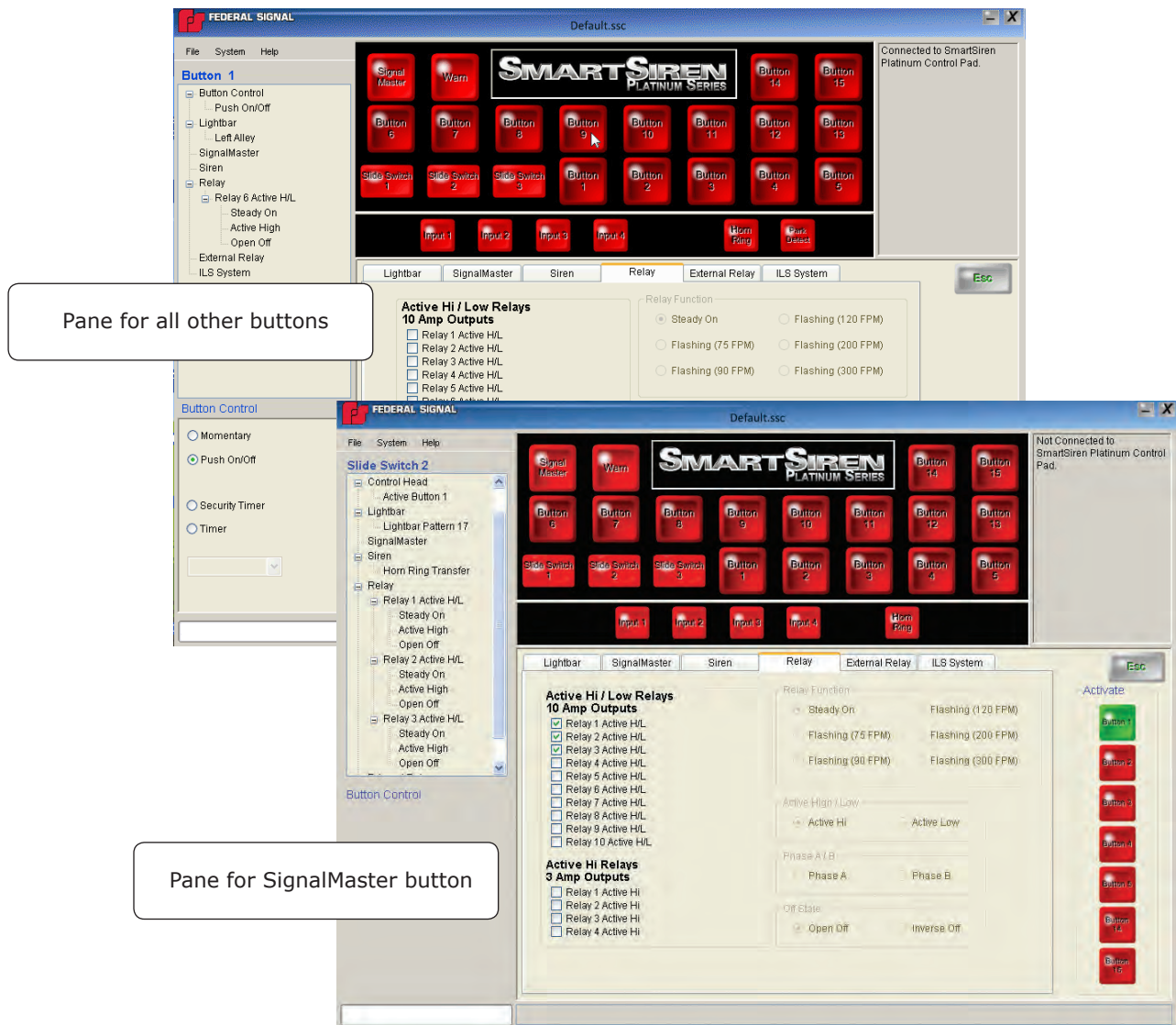

Relay Default Settings

Before you begin, you may want to review these relay default settings. For an keypad view of the default settings, see the table in the appendix on page 115.

Button	Relay	Button Control	Relay Function	Active State	Off State
Button 1	Active H/L Relay 6	Push On/Off	Steady On	Active High	Open Off
Button 2	Active H/L Relay 7	Push On/Off	Steady On	Active High	Open Off
Button 3	Active H/L Relay 8	Push On/Off	Steady On	Active High	Open Off
Button 5	Active H/L Relay 10	Security Timer: 8 Seconds	Steady On	Active High	Open Off
Button 8	Active H/L Relay 9	Push On/Off	Steady On	Active High	Open Off

Configuring the Internal Relays (Buttons 1 to 15 and Inputs)

To assign a relay function to a button:

1. Click a button in the **Button Configuration Module**.

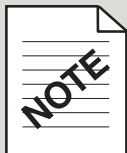

Button Function Limits

The functions for all buttons (except **Slide Switch 3**, which accepts a limit of 20) are limited to a maximum of 10.

2. If the **Relay** pane is not in front of the other **Device Selection** panes, click the **Relay** tab.

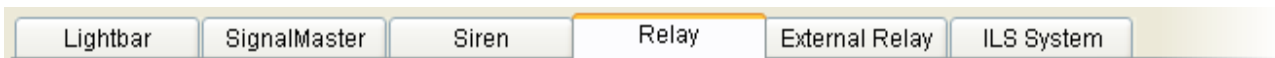

3. Select how you want the button to operate the relay by clicking an option button in the **Button Control** pane. If you want the button to act as a timer, select the duration from the drop-down list. **Buttons 1–13** have the additional **Button Control** option to be **Exclusive**. They turn on a function when pressed and turn off the button that was pressed previously in the same row.

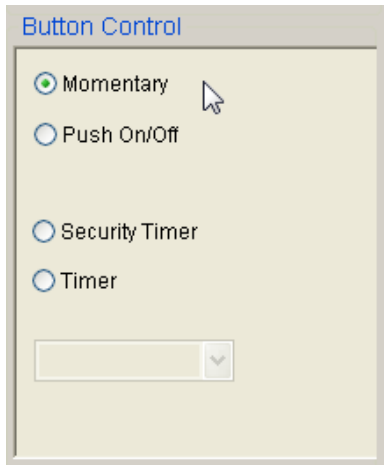

4. Select a relay for configuration. The relay is highlighted so that you can easily see it for editing. The other relays dim until you complete the configuration of the relay by selecting the options on the right. For a description of the options, see the tables on pages 79 and 80.

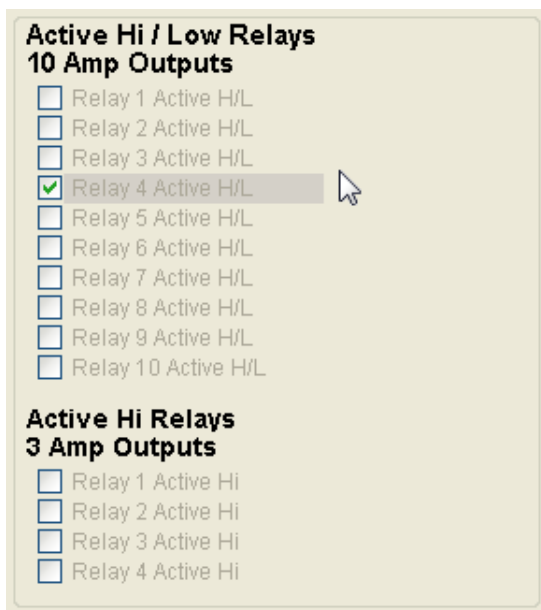

NOTE

“Edit Relay Function?”

If you try to change the settings for a relay output stored in the **Button Configuration Module**, a prompt asks you to verify the change before you continue. Click **Yes** to retain the check next to the relay and clear the selections on the right half of the screen. Click **No** to clear all selections.

5. If the relay controls one or more flashing lights, select **Steady On** or a flash rate.

Relay Function

Steady On Flashing (120 FPM)

Flashing (75 FPM) Flashing (200 FPM)

Flashing (90 FPM) Flashing (300 FPM)

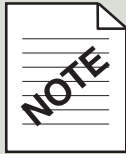

Changing your relay selections

Selections become available as you progress through the pane. You must complete all selections before you can go back and edit your selections.

6. Select an active state. **Active High/Low** selections are not available for **Relays 11–14**, which are active high only.

Active High / Low

Active Hi Active Low

7. If you selected a flash rate for two or more lights, select whether they flash in synch (**Phase A**) or alternate (**Phase B**).

Phase A / B

Phase A Phase B

8. Select the **Off State** of the relay.

Off State

Open Off Inverse Off

9. Verify your settings in the **Button Configuration Module**.

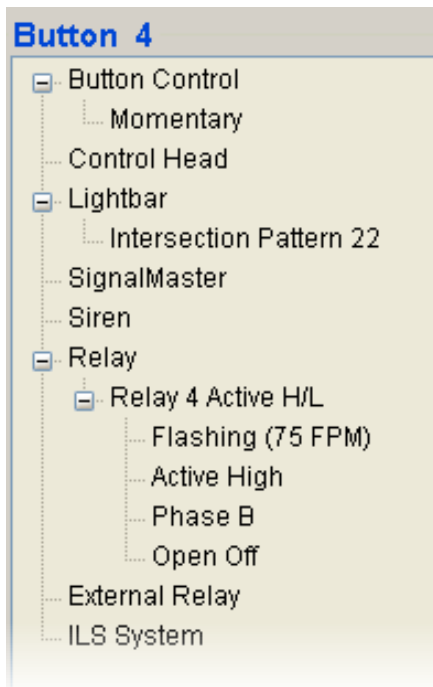

10. When you are finished, select **Save** or **Save As** from the **File** menu, and save the configuration file in the folder you created on your hard drive.

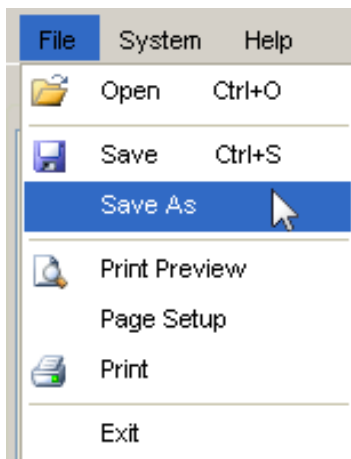

Pop-Up Message: "Overwriting the Default Configuration"

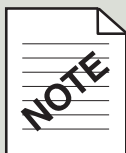

When you select **Save** for the first time, the message "Trying to overwrite protected default configuration" appears. Click **OK**. In the **Save As** dialog box, navigate to the folder you created for your configuration files and save the file under a new name. When you click **Save** again before closing the application, it updates your renamed file by overwriting it.

Configuring the Internal Relays for the Slide Switch Buttons

1. Click a **Slide Switch** button.

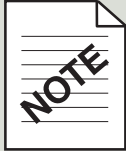

Button Function Limits

The functions for all buttons (except **Slide Switch 3**, which accepts a limit of 20) are limited to a maximum of 10.

2. If the **Siren** pane is not in front of the other **Device Selection** panes, click the **Siren** tab.

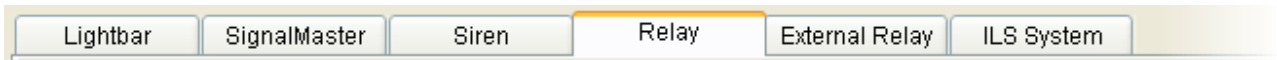

3. Select a relay for configuration. The relay is highlighted so that you can easily see it for editing. The other relays dim until you complete the configuration of the relay by selecting the options on the right. For a description of the options, see the tables on pages 79 and 80.

Active Hi / Low Relays 10 Amp Outputs

- Relay 1 Active H/L
- Relay 2 Active H/L
- Relay 3 Active H/L
- Relay 4 Active H/L
- Relay 5 Active H/L
- Relay 6 Active H/L
- Relay 7 Active H/L
- Relay 8 Active H/L
- Relay 9 Active H/L
- Relay 10 Active H/L

Configuring the Internal Relays

- Click a button to activate it (green) in the selected slide switch position. Select additional buttons if you want to turn on or off their assigned functions along with the function assigned to the slide switch position.

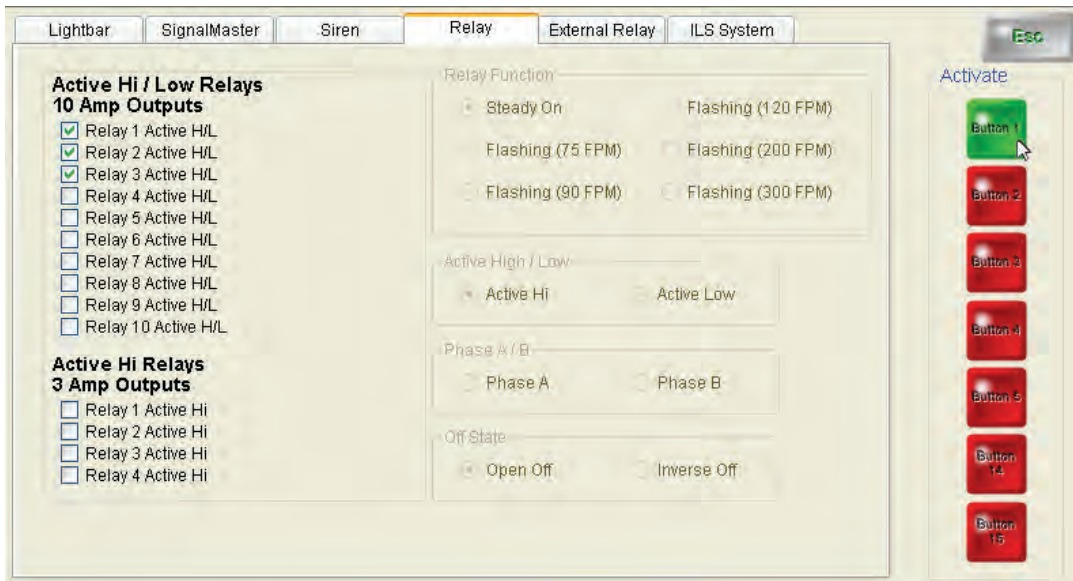

- Verify your settings in the **Button Configuration Module**.

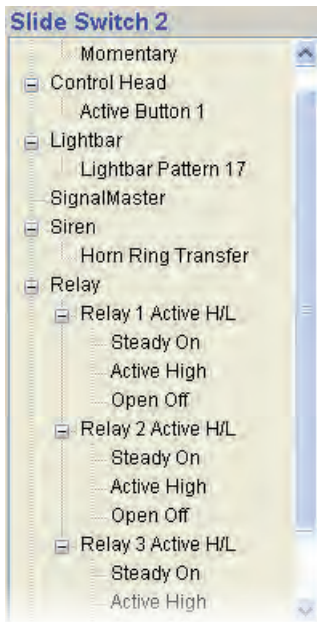

Configuring the Internal Relays

- When you are finished, select **Save** or **Save As** from the **File** menu, and save the configuration file in the folder you created on your hard drive.

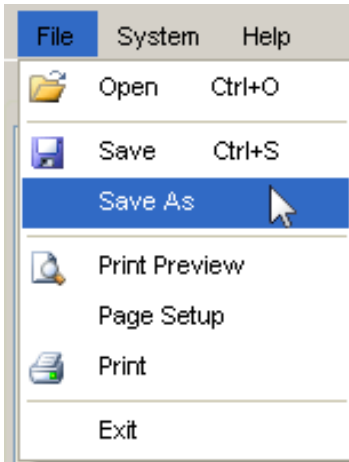

Pop-Up Message: "Overwriting the Default Configuration"

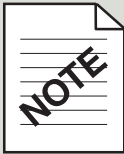

When you select **Save** for the first time, the message "Trying to overwrite protected default configuration" appears. Click **OK**. In the **Save As** dialog box, navigate to the folder you created for your configuration files and save the file under a new name. When you click **Save** again before closing the application, it updates your renamed file by overwriting it.

Pins for Internal Solid State Relay

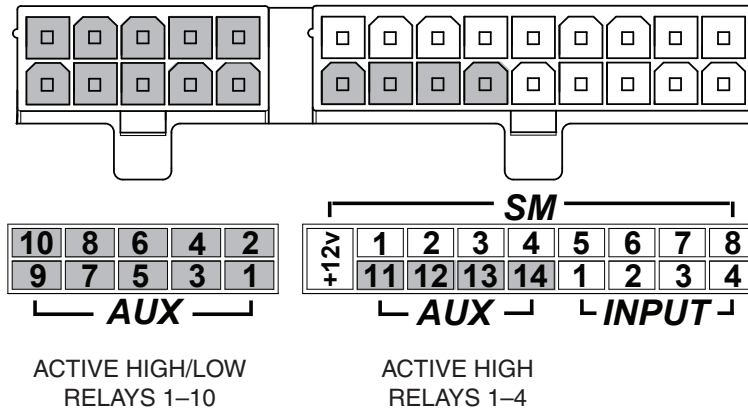

Switch Positions for Internal Solid State Relays

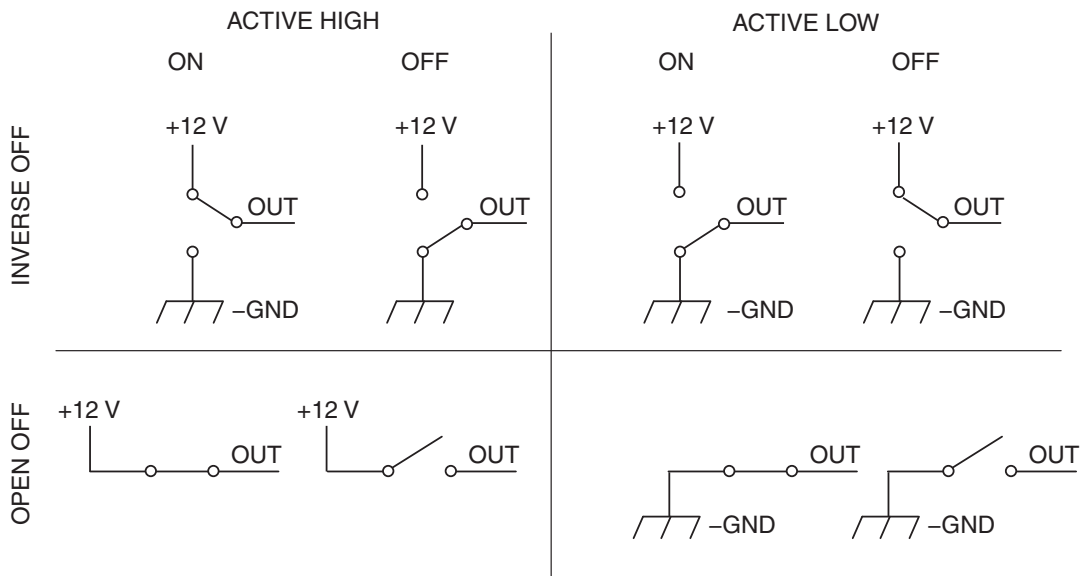

Function	Description
<input type="radio"/> Active High	The normally closed (NC) relay supplies +12 Vdc during the "on" state.
<input type="radio"/> Active Low	The NC relay supplies ground during the "on" state.
<input type="radio"/> Open Off	The NC relay is open during the "off" state, a condition similar to an open electromechanical relay.
<input type="radio"/> Inverse Off	The NC relay alternates from its former polarity to the other each time it is in the "off" state.

Flash Functions for Perimeter Lights: Internal Relays

Function	Description
<input type="radio"/> Flashing (FPM)	Five common flash patterns from 75 FPM to 300 FPM are available for perimeter lights.
<input type="radio"/> Steady On	One or more lights stay on and do not flash.
<input type="radio"/> Phase A	Two or more lights flash in synch.
<input type="radio"/> Phase B	Two or more lights flash alternately with a 90-degree phase shift.

CHAPTER 8

Configuring the External Relay

An Overview of the External Relay

The External Relay is the Federal Signal Model 660100 Relay Module/Two-Channel Flasher. It is used either in place of, or in addition to, the SmartSiren Platinum Siren Amplifier in the Convergence Network. The Model 660100 connects to the SmartSiren Platinum Siren Amplifier through an RS-485 serial cable. The relay controls up to four different devices. Two of the devices can be flashing perimeter lights, such as the Impaxx® or Viper® that are activated into the built-in two-channel flasher. There are 12 selectable flash patterns and two options to alternate the flashing of two or more lights. For more information, see Federal Signal Doc. No. 2562431.

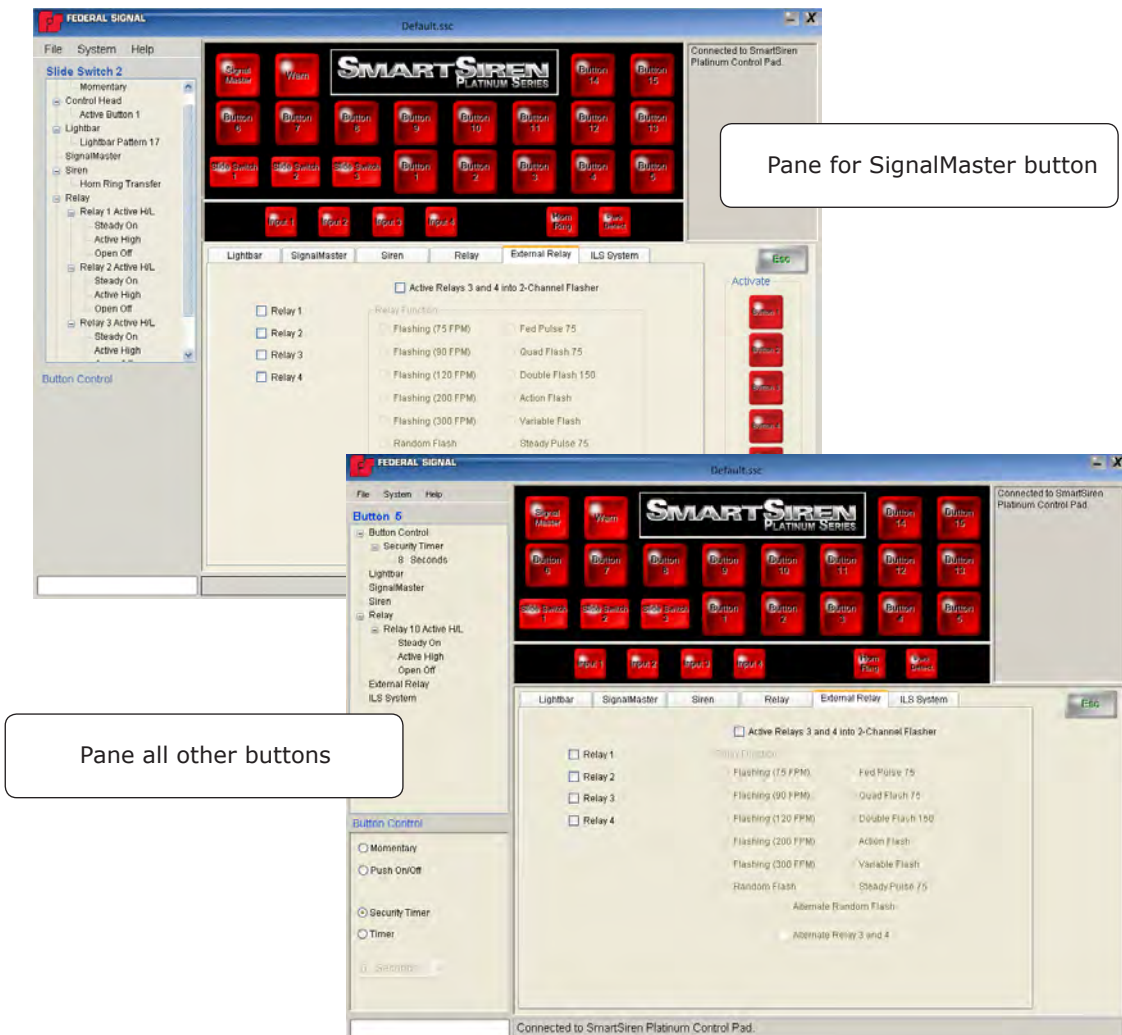

Configuring the External Relay

There are no default settings for the **External Relay**.

To assign an **External Relay** function to a button:

1. Click a button in the **Button Configuration Module**.

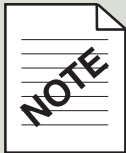

Button Function Limits

The functions for all buttons (except **Slide Switch 3**, which accepts a limit of 20) are limited to a maximum of 10.

2. If the **External Relay** pane is not in front of the other **Device Selection** panes, click the **External Relay** tab.

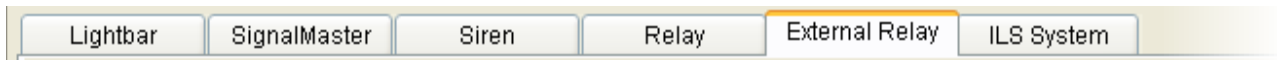

3. Select how you want the button to operate by clicking an option button in the **Button Control** pane. If you want the button to act as a timer, select the duration from the drop-down list. Some buttons have the additional **Button Control** option to be **Exclusive**. They turn on a function when pressed and turn off the button that was pressed previously in the same row.

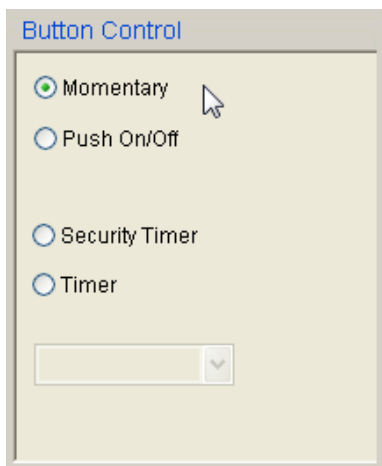

Configuring the External Relay

4. Select one relay per button. If you are using the two-channel flasher, skip this step and select the option **Activate Relays 3 and 4 into 2-Channel Flasher**.

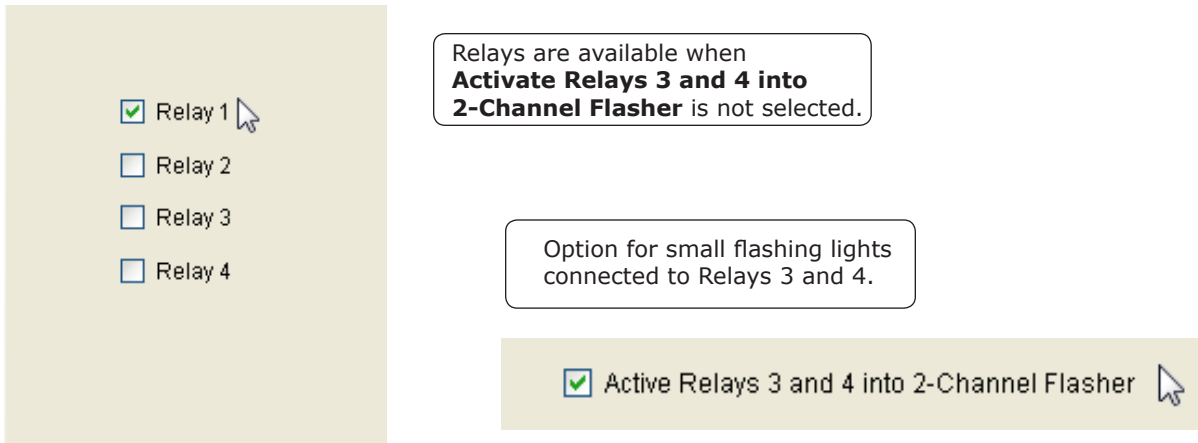

The screenshot shows a configuration interface with a light beige background. On the left, there is a vertical list of four checkboxes: 'Relay 1' (checked), 'Relay 2', 'Relay 3', and 'Relay 4'. To the right of this list, there is a callout box with a black border containing the text: 'Relays are available when **Activate Relays 3 and 4 into 2-Channel Flasher** is not selected.' Below this callout is another callout box with a black border containing the text: 'Option for small flashing lights connected to Relays 3 and 4.' At the bottom right, there is a horizontal bar with a checked checkbox and the text 'Active Relays 3 and 4 into 2-Channel Flasher'.

5. If you have selected the two-channel flasher, select a **Relay Function** flash pattern. For information on these options, see the table on page 88.

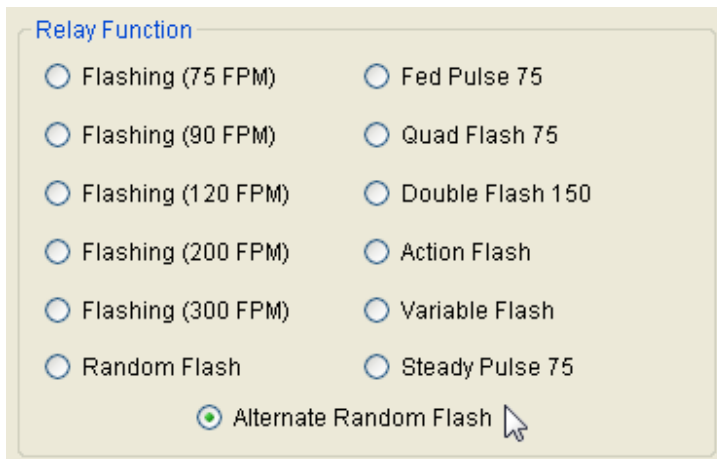

The screenshot shows a 'Relay Function' selection interface with a light beige background. The title 'Relay Function' is at the top left. Below it, there are two columns of radio button options. The first column includes: 'Flashing (75 FPM)', 'Flashing (90 FPM)', 'Flashing (120 FPM)', 'Flashing (200 FPM)', 'Flashing (300 FPM)', and 'Random Flash'. The second column includes: 'Fed Pulse 75', 'Quad Flash 75', 'Double Flash 150', 'Action Flash', 'Variable Flash', and 'Steady Pulse 75'. At the bottom, the option 'Alternate Random Flash' is selected and has a mouse cursor over it.

6. If you have selected a **Relay Function** flash pattern for a series of two or more lights, select if you want the lights to alternately flash the pattern.

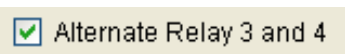

The screenshot shows a single checked checkbox with the text 'Alternate Relay 3 and 4' next to it.

7. Verify your settings in the **Button Configuration Module**.

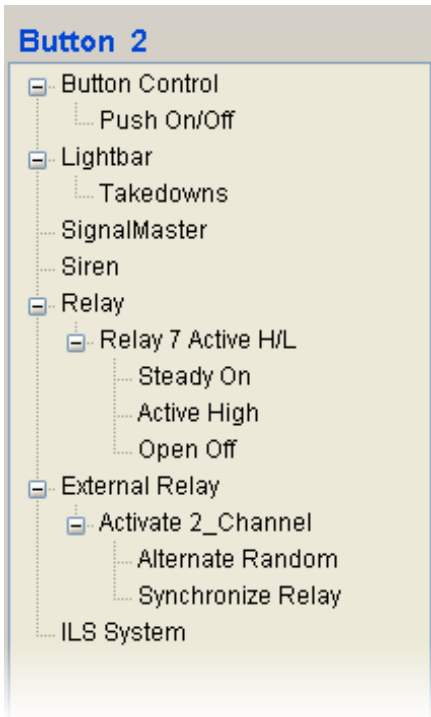

8. When you are finished, press **CTRL + S**, or select **Save** or **Save As** from the **File** menu, and save the configuration file in the folder you created on your hard drive.

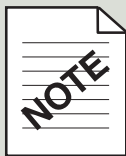
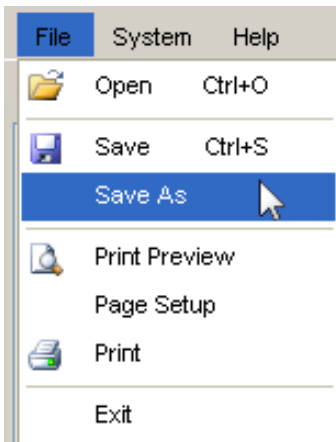

Pop-Up Message: "Overwriting the Default Configuration"

When you select **Save** for the first time, the message "Trying to overwrite protected default configuration" appears. Click **OK**. In the **Save As** dialog box, navigate to the folder you created for your configuration files and save the file under a new name. When you click **Save** again before closing the application, it updates your renamed file by overwriting it.

Configuring the External Relay for the Slide Switch Buttons

1. Click a **Slide Switch** button.

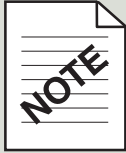

Button Function Limits

The functions for all buttons (except **Slide Switch 3**, which accepts a limit of 20) are limited to a maximum of 10.

2. If the **External Relay** pane is not in front of the other **Device Selection** panes, click the **External Relay** tab.

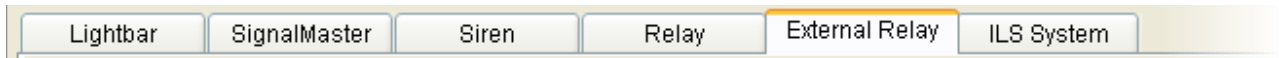

3. Select a relay for configuration. The relay is highlighted so that you can easily see it for editing. The other relays dim until you complete the configuration of the relay by selecting the options on the right. For a description of the options, see the tables on pages 75 and 76.

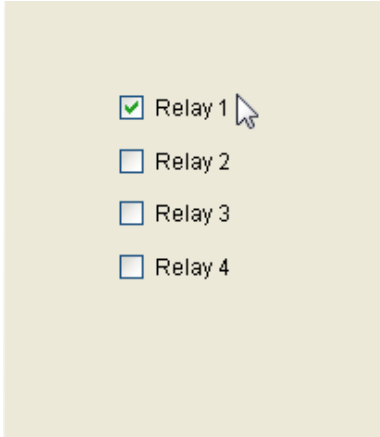

Relays are available when **Activate Relays 3 and 4 into 2-Channel Flasher** is not selected.

Option for small flashing lights connected to Relays 3 and 4.

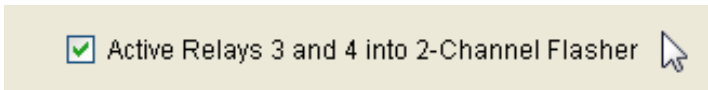

Configuring the External Relay

- Click a button to activate it (green) in the selected slide switch position. Select additional buttons if you want to turn on or off their assigned functions along with the function assigned to the slide switch position.



- Select a relay. If you are using the two-channel flasher, skip this step and select the option **Activate Relays 3 and 4 into 2-Channel Flasher**.



Configuring the External Relay

- If you have selected the two-channel flasher, select a **Relay Function** flash pattern. For information on these options, see the table on page 88.

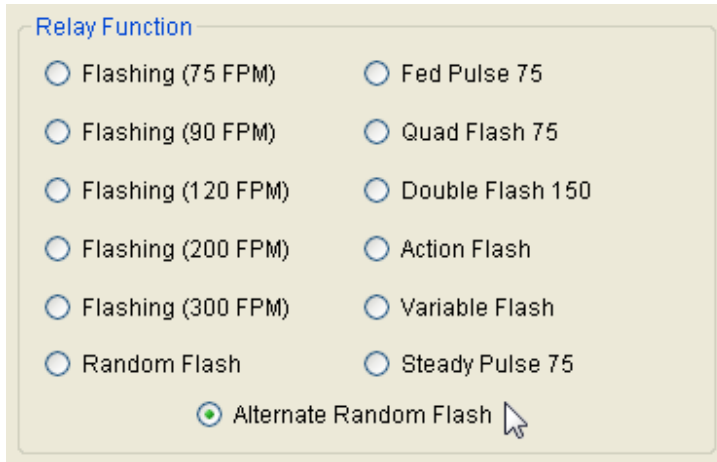

- If you have selected a **Relay Function** flash pattern for a series of two or more lights, select if you want the lights to alternately flash the pattern.

Alternate Relay 3 and 4

- Verify your settings in the **Button Configuration Module**.

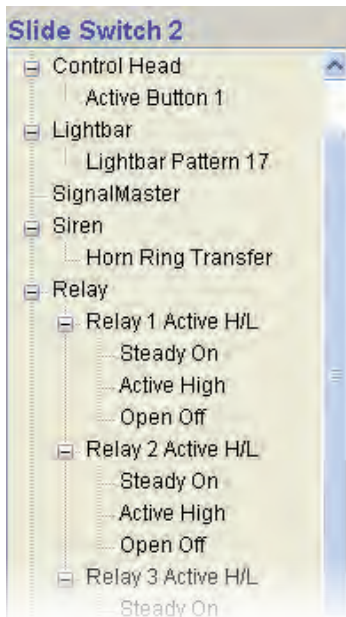

Configuring the External Relay

- When you are finished, press **CTRL + S**, or select **Save** or **Save As** from the **File** menu, and save the configuration file in the folder you created on your hard drive.

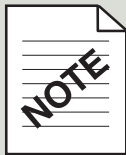
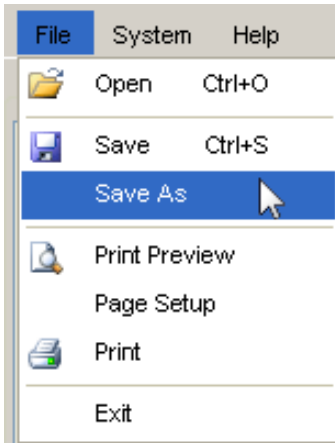

Pop-Up Message: "Overwriting the Default Configuration"

When you select **Save** for the first time, the message "Trying to overwrite protected default configuration" appears. Click **OK**. In the **Save As** dialog box, navigate to the folder you created for your configuration files and save the file under a new name. When you click **Save** again before closing the application, it updates your renamed file by overwriting it.

Flash Functions for Perimeter Lights: External Relay

<i>Function</i>	<i>Description</i>
<input type="radio"/> Flashing (FPM)	Five common flash patterns from 75 FPM to 300 FPM are available for perimeter lights. Unique flash patterns, such as FedPulse 75 and Action Flash, vary depending on whether the Federal Signal light is a solid color model or split color combination model. For more details, refer to the instructions included with the lights.
<input type="checkbox"/> Alternate Relay 3 and 4	Alternates the flashing of the lights connected to Relays 3 and 4 .

CHAPTER 9

Configuring the ILS System

An Overview of the ILS System

The ILS System comprises three models of single-level LED lightbars—**Front ILS**, **Rear Lower ILS**, and **Rear Upper ILS**—that mount on the inside of the windshield of an emergency vehicle. They have many of the features of a full-featured Federal Signal Lightbar including a library of flash patterns, Front and Rear Light Cut-Off, Takedown lights, Steady Burn LEDs and SignalMaster capability (see “Chapter 5: Configuring the SignalMaster” on page 44).

Each ILS lightbar is connected to the Convergence Network through a CAT5 serial communication cable that connects to the back of the SmartSiren Platinum Siren Amplifier.

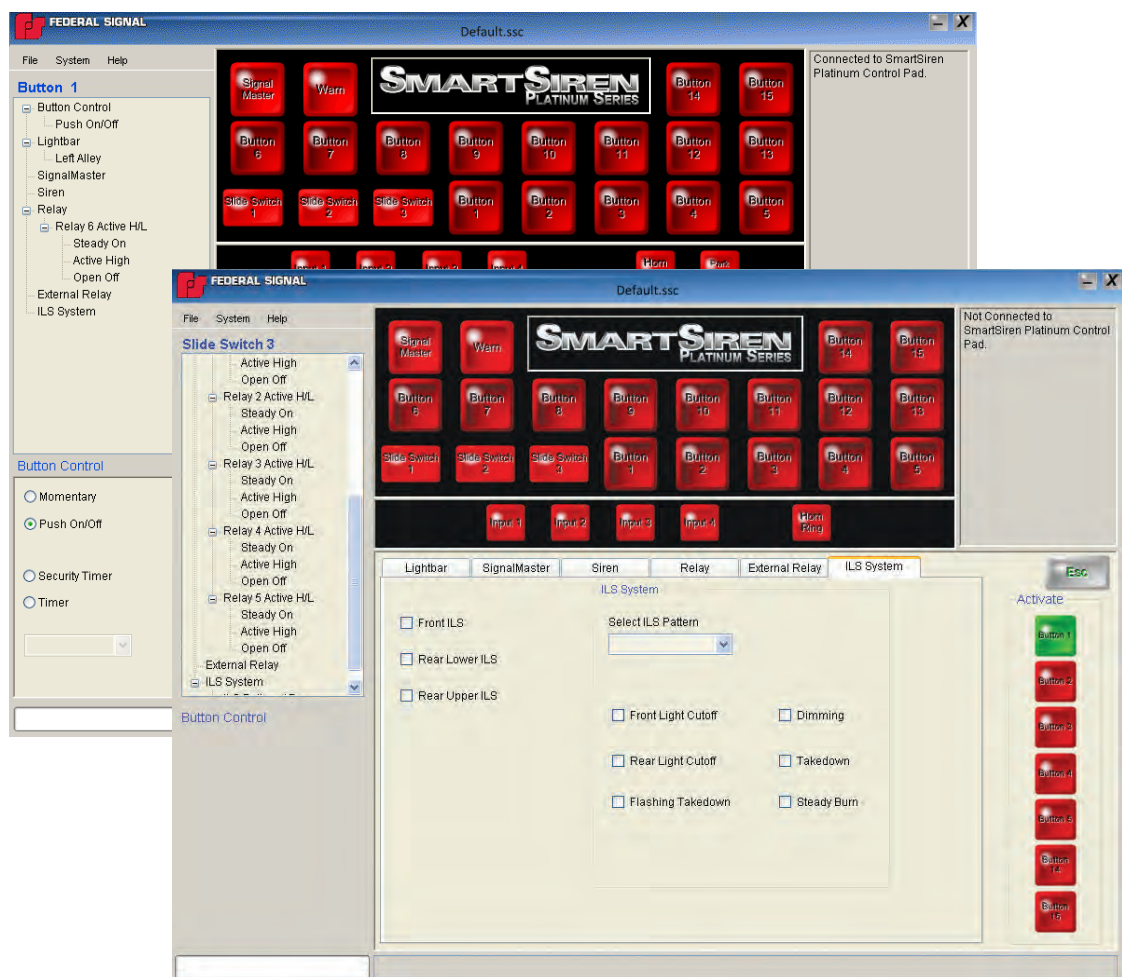

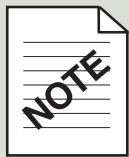

Verify features before configuring the lightbar

Federal Signal ILS lightbars may not have all the features available in the lightbar pane. To make the software configuration of the control pad quick and accurate, determine what hardware features and DIP switch settings are in the lightbar before you begin. Refer to "Setting Configuration Options" for the Rear ILS lightbar in Doc. No. 2562422 and "Setting Configuration Options" for the Front ILS lightbar in Doc. No. 2562423.

Configuring the ILS System

There are no default settings for the **ILS System**.

To assign an **ILS System** function to a button:

1. Click a button in the **Button Configuration Module**.

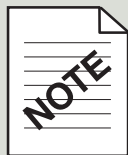

Button Function Limits

The functions for all buttons (except **Slide Switch 3**, which accepts a limit of 20) are limited to a maximum of 10.

2. Select how you want the button to operate by clicking an option button in the **Button Control** pane. If you want the button to act as a timer, select the duration from the drop-down list. **Buttons 1–13** have the additional **Button Control** option to be **Exclusive**. They turn on a function when pressed and turn off the button that was pressed previously in the same row.

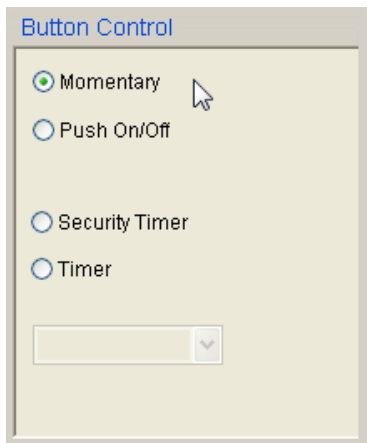

3. If the **ILS System** pane is not in front of the other **Device Selection** panes, click the **ILS System** tab.

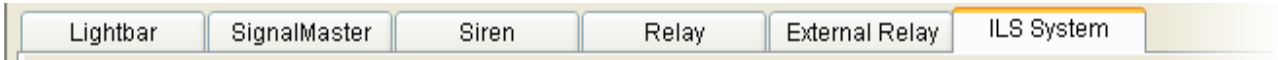

4. Select the ILS lightbars in the Convergence Network. The dimmed options for the **ILS System** on right side of the pane become available when you select the type of lightbar that uses them. For a description of the ILS System functions, see the table on page 97.

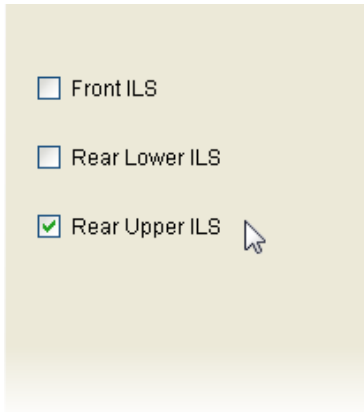

5. Select a flash pattern for the **ILS System**. All ILS lightbars assigned to the button flash the same selected pattern.

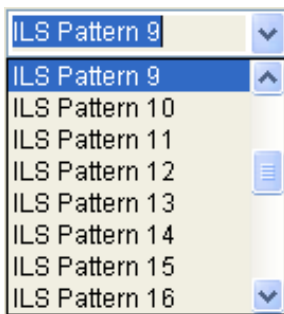

Available flash patterns

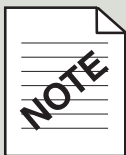

Some lightbars have fewer or more flash patterns than are available in the drop-down list. Lightbars that have fewer patterns are restricted to the last pattern available in the pattern library within the lightbar. Lightbars that have more patterns are restricted to the number available in the drop-down list.

For more information about flash patterns, consult the instruction manual for your model of lightbar.

Configuring the ILS System

6. Select functions for the **ILS System**. All ILS lightbars assigned to the button will operate the function.

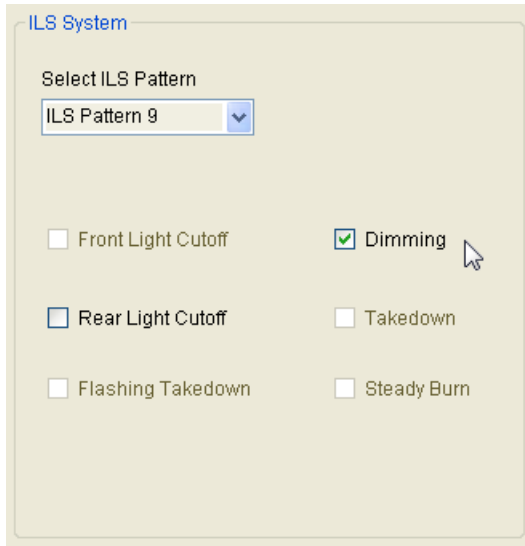

7. Verify your settings in the **Button Configuration Module**.

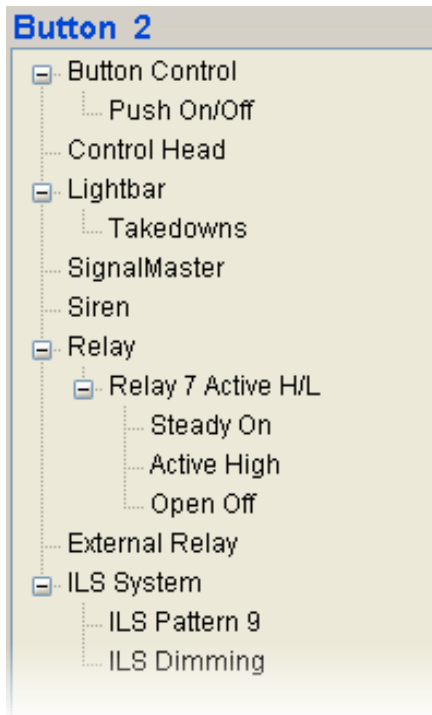

- When you are finished, press **CTRL + S**, or select **Save** or **Save As** from the **File** menu, and save the configuration file in the folder you created on your hard drive.

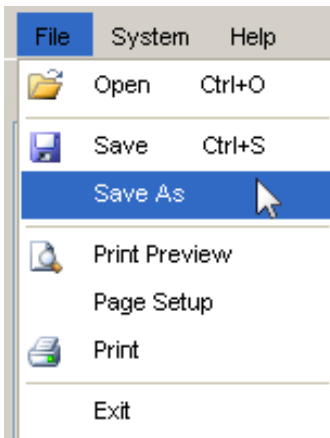

Pop-Up Message: "Overwriting the Default Configuration"

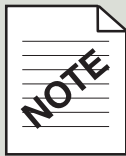

When you select **Save** for the first time, the message "Trying to overwrite protected default configuration" appears. Click **OK**. In the **Save As** dialog box, navigate to the folder you created for your configuration files and save the file under a new name. When you click **Save** again before closing the application, it updates your renamed file by overwriting it.

Configuring the ILS System for the Slide Switch Buttons

- Click a **Slide Switch** button.



Button Function Limits

The functions for all buttons (except **Slide Switch 3**, which accepts a limit of 20) are limited to a maximum of 10.

- If the **ILS** pane is not in front of the other **Device Selection** panes, click the **ILS** tab.



Configuring the ILS System

- Click a button to activate it (green) in the selected slide switch position. Select additional buttons if you want to turn on or off their assigned functions along with the function assigned to the slide switch position.

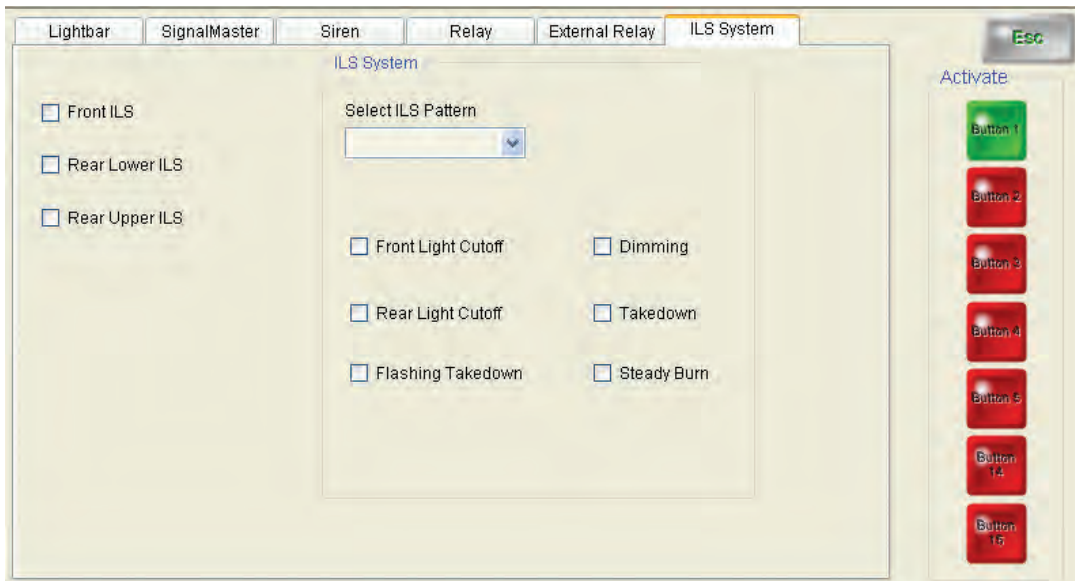

- Select the ILS lightbars in the Convergence Network. The dimmed options for the **ILS System** on right side of the pane become available when you select the type of lightbar that uses them. For a description of the function, see the table on page 97.

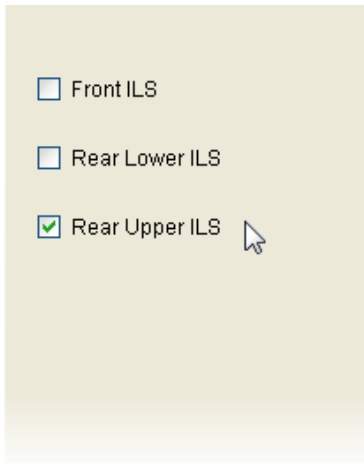

5. Select a flash pattern for the **ILS System**. All ILS lightbars assigned to the button will flash the same pattern.

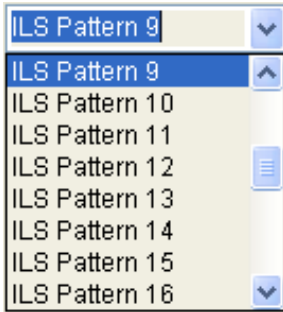

Available flash patterns

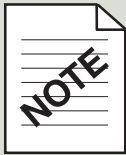

Some lightbars have fewer or more flash patterns than are available in the drop-down list. Lightbars that have fewer patterns are restricted to the last pattern available in the pattern library within the lightbar. Lightbars that have more patterns are restricted to the number available in the drop-down list.

For more information about flash patterns, consult the instruction manual for your model of lightbar.

6. Select functions for the **ILS System**. All ILS lightbars assigned to the button will operate the function.

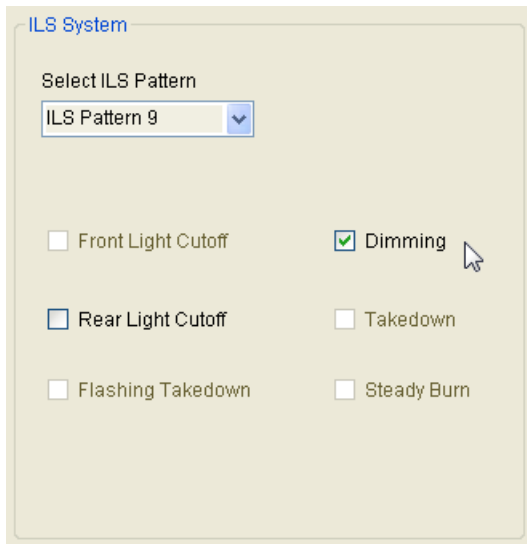

7. Verify your settings in the **Button Configuration Module**.

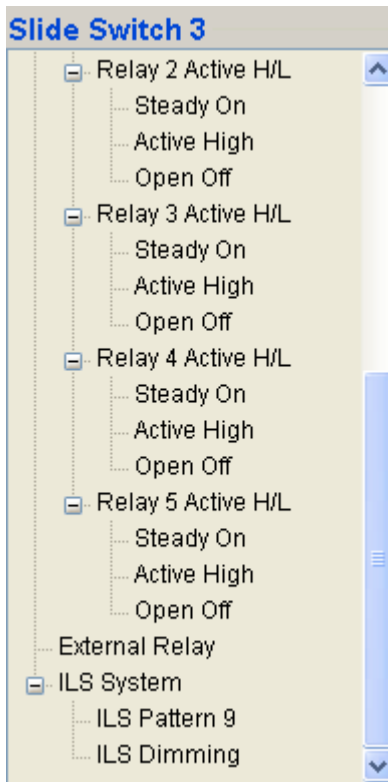

8. When you are finished, press **CTRL + S**, or select **Save** or **Save As** from the **File** menu, and save the configuration file in the folder you created on your hard drive.

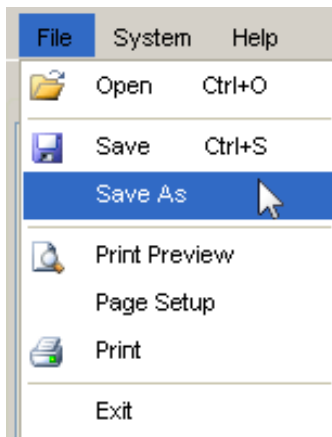

ILS System Functions

Function

Description

<input type="checkbox"/> Front ILS	A single-level LED lightbar that mounts on the inside of the front windshield. It uses ROC (Reliable On Board Circuitry) technology, and Solaris® S2 reflectors.
<input type="checkbox"/> Rear Lower ILS	A single-level LED lightbar that mounts on the rear deck of an emergency vehicle. It uses ROC (Reliable On Board Circuitry) technology, and Solaris® S2 reflectors.
<input type="checkbox"/> Rear Upper ILS	A single-level LED lightbar that mounts on the upper part of the rear windshield of an emergency vehicle. It uses ROC (Reliable On Board Circuitry) technology, and Solaris® S2 reflectors.
<input type="checkbox"/> Front Light Cutoff	Turns off light on the front of the lightbar.
<input type="checkbox"/> Rear Light Cutoff	Turns off light on the rear of the lightbar.
<input type="checkbox"/> Flashing Takedown	Flashes the takedown and alley lights.
<input type="checkbox"/> Dimming	Dims the lights approximately 50 percent to prevent blinding approaching drivers at night.
<input type="checkbox"/> Takedown	White light directed to the front of the vehicle.
<input type="checkbox"/> Steady Burn	One or more lights that stay on and do not flash.

CHAPTER 10

Completing the Control Pad Configuration

Final Steps in Completing the Configuration

When you are finished configuring the SmartSiren Platinum control pad and network devices, there are a few more steps before the SmartSiren Platinum system is ready to be put to work. To successfully complete your task, the topics in this chapter should be followed in the order they are presented.

Saving Your Completed Configuration File

If you have not already saved your configuration file, select **Save** or **Save As** from the **File** Menu, and save the configuration file in the folder you created on your hard drive.

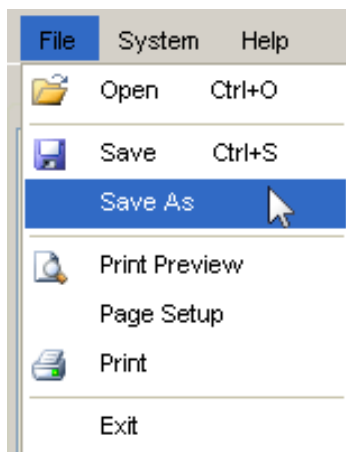

Printing a Record of Your Configuration File

The **Print** command in the **File Menu** prints a copy of the configuration window for the button and assigned device you select.

To print a record of your configuration:

1. Click a button and the tab of a device assigned to it to display settings for the button.

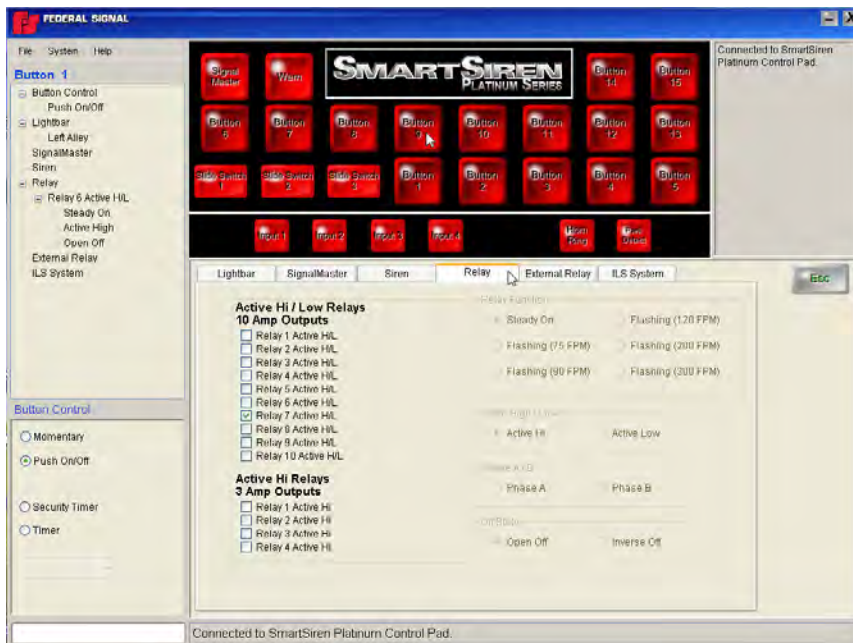

2. Select **Page Setup** to open a dialogue box of print settings. Select the paper size, orientation, margins, and printer, then click **OK**.

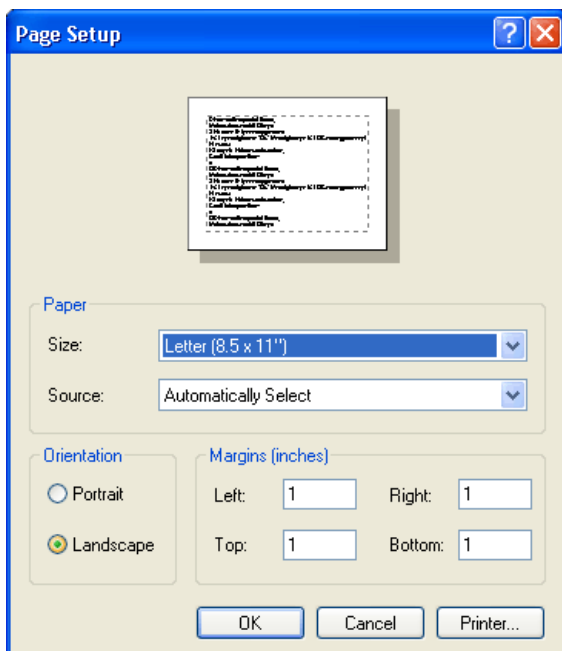

Completing the Control Pad Configuration

3. In the **File** menu select **Print Preview** to display a preview of the page layout of the window you want to print.

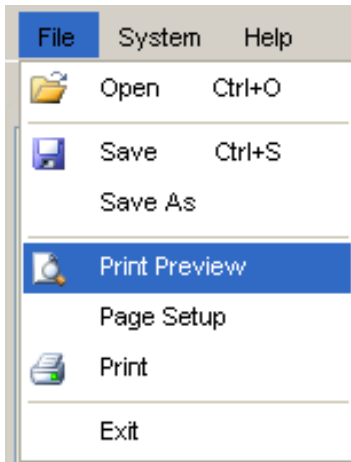

4. If the page displays correctly, click the print icon the upper left corner. Continue printing the window for each button until you have a complete record.

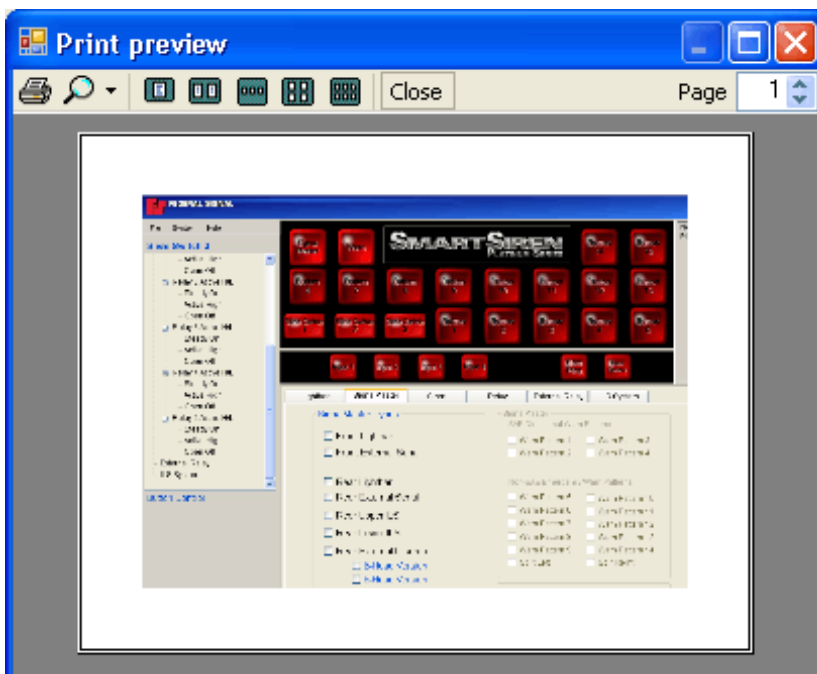

Uploading the Configuration File to the Control Pad

Uploading the configuration file stores the file in the flash memory of the control pad.

To upload a configuration file:

1. In the **System** menu select **Program Control Head**.

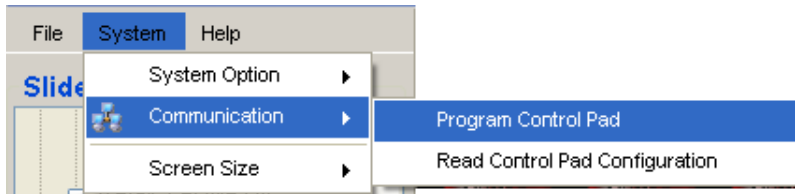

2. Wait until the progress bar fills from left to right. When the upload is complete, the file is stored in the flash memory of the control pad.

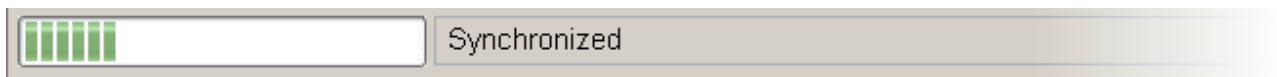

Putting the Control Pad into Operation Mode

For the SmartSiren Platinum system to follow the instructions in the configuration file, the control pad must be put into Operation Mode.

1. Press **Button 13**. The first LED blinks and the control pad beeps to indicate you are in Programming Mode.

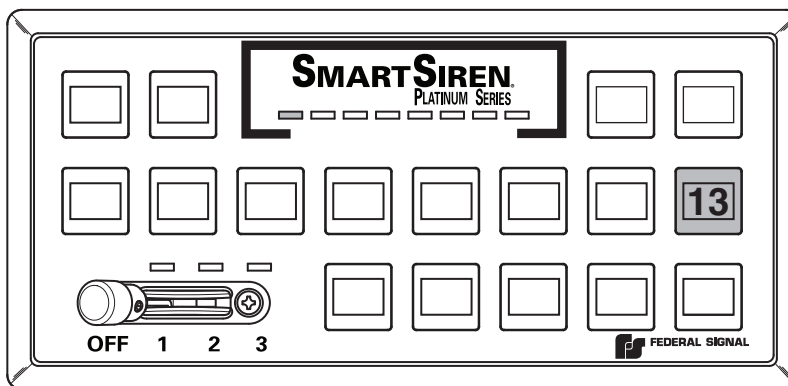

2. Remove 12 Vdc power from the control pad, then reapply it. The control pad is in Operation Mode and ready to control the SmartSiren Platinum system.

Testing the SmartSiren Platinum System

⚠ WARNING

SOUND HAZARD

All effective sirens and horns produce loud sounds (120 dB) that may cause permanent hearing loss. Always minimize your exposure to the sound of the siren and horn and wear hearing protection. Do not sound the siren or horn indoors or in enclosed areas where you and others will be exposed to the sound.

⚠ WARNING

LIGHT HAZARD

To be an effective warning device, an emergency warning system produces bright light that can be hazardous to your eyesight when viewed at a close range. Do not stare directly into this lighting product at a close range or permanent damage to your eyesight may occur.

After programming the control pad, test the emergency warning system to ensure that it is operating properly. Also test all vehicle functions, including horn operation, vehicle safety functions, and vehicle lighting systems to ensure proper operation. Ensure that the installation has not affected the vehicle operation or changed any vehicle safety functions or circuits. After testing is complete, provide a copy of these instructions to the instructional staff and all operating personnel.

Do not test the sound and light system of the vehicle while driving. Operating the vehicle warning systems may pose a hazard to the operator and other drivers if the systems do not function as expected. Test the vehicle only in a controlled environment.

APPENDIX

IP Connection Troubleshooting, Control-Pad Default Configuration and Worksheet

Troubleshooting Your IP Connection in Windows XP

If the Connection Status Pane displays the message “Not Connected to Smart Siren Platinum Control Pad” after you have properly connected the system and tried to establish an IP connection between the control pad and your computer:

1. Check the IP connection between the control pad and your computer:
 - a) To power the control pad, turn the ignition key to the accessories position. When powered on, the control pad automatically provides a IP address to the computer.
 - b) In the **Start** menu click **Connect to** and select **Open**.

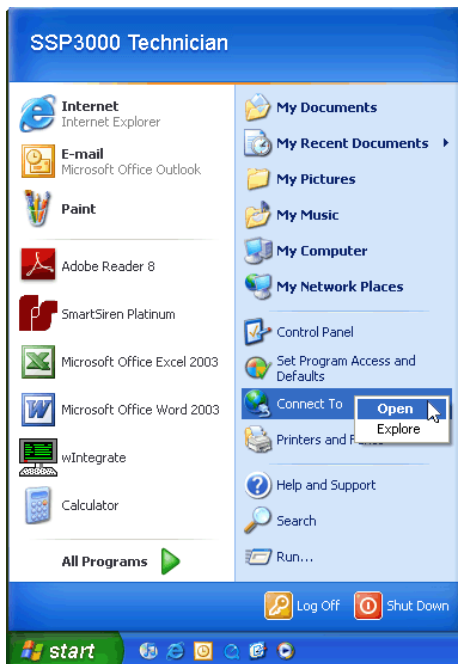

c) Right-click **Local Area Connection** and select **Status**.

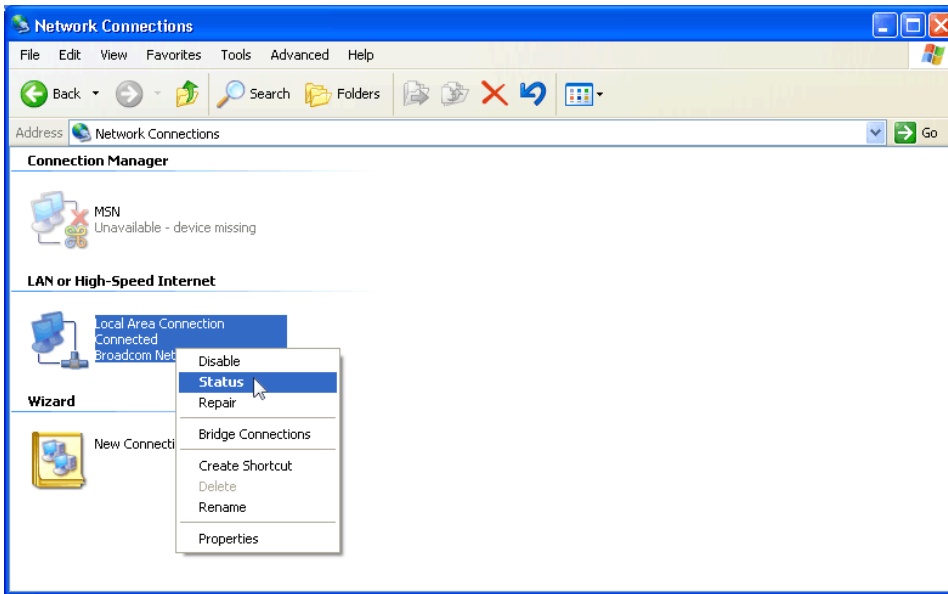

d) Click the **Support** tab. The **IP Address**, **Subnet Mask**, and **Default Gateway** should match the information in the illustration below. Click **Close** to exit. If they do not match those in the illustration, see "Resetting the IP Address in Windows XP" on page 105.

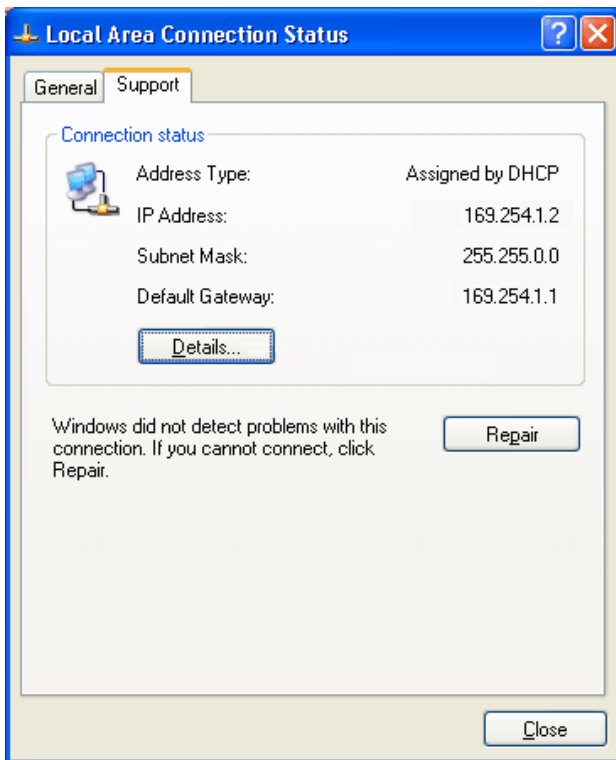

Resetting the IP Address in Windows XP

If the **IP Address**, **Subnet Mask**, and **Default Gateway** do not match the illustration in step 6 on page 107, reset the network connection by disabling and enabling it:

1. In the **Start** menu click **Connect to** and select **Open**.

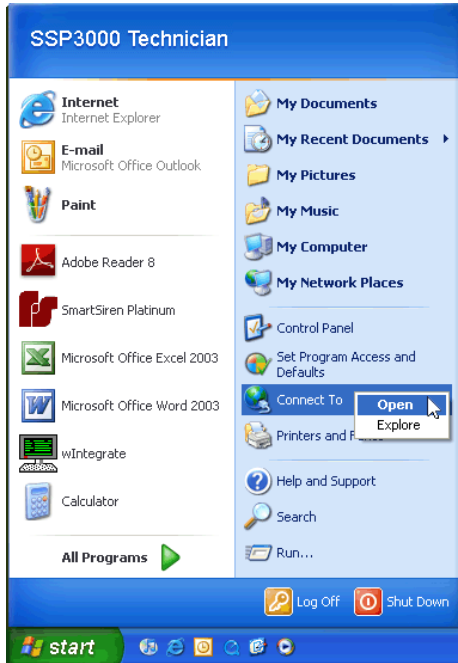

2. Under **LAN or High-Speed Internet**, right-click **Local Area Connection** and select **Disable**.

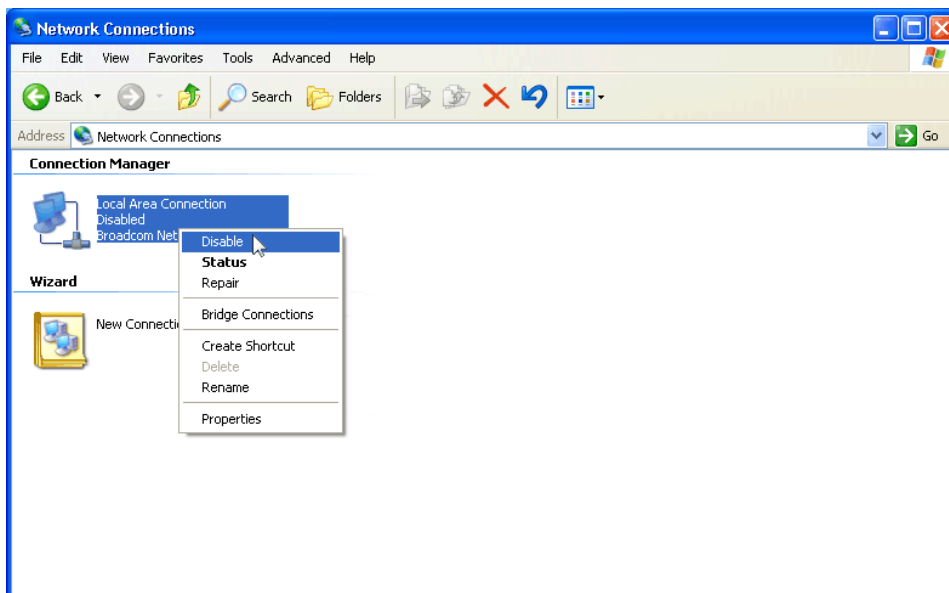

3. Wait for the connection to be disabled, then right-click **Local Area Connection** and select **Enable**.

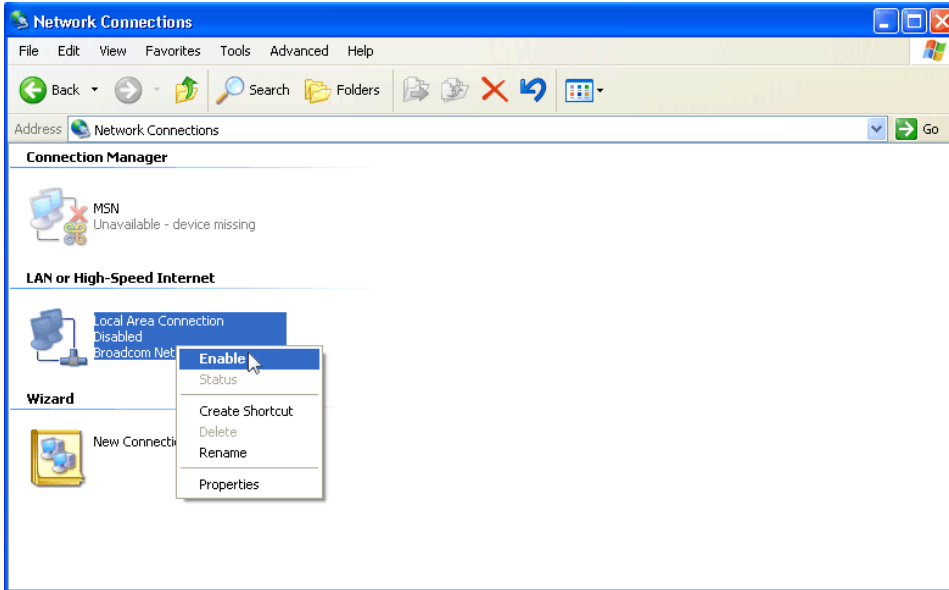

4. Wait for Windows XP to reconnect to the network.

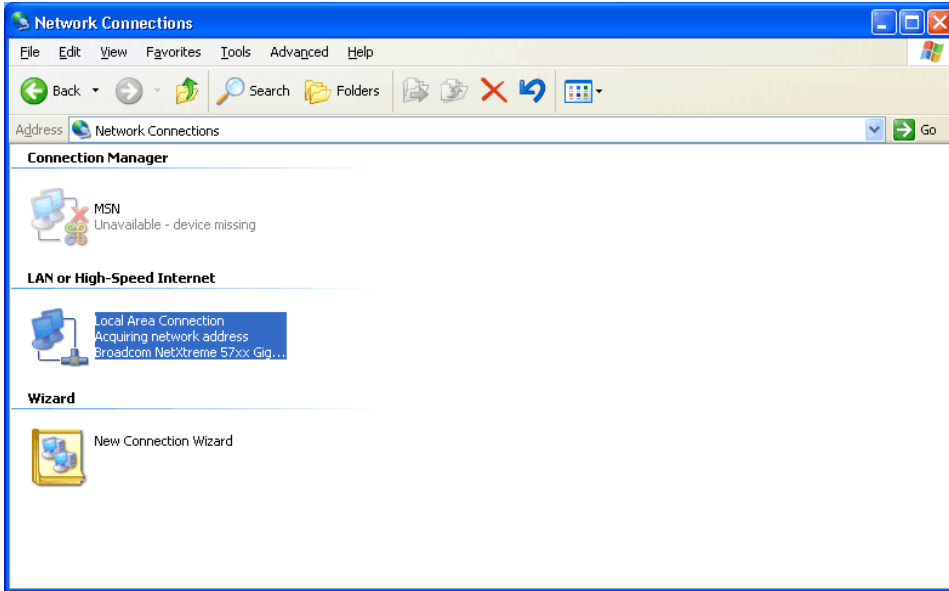

5. Right-click **Local Area Connection** again and select **Status**.

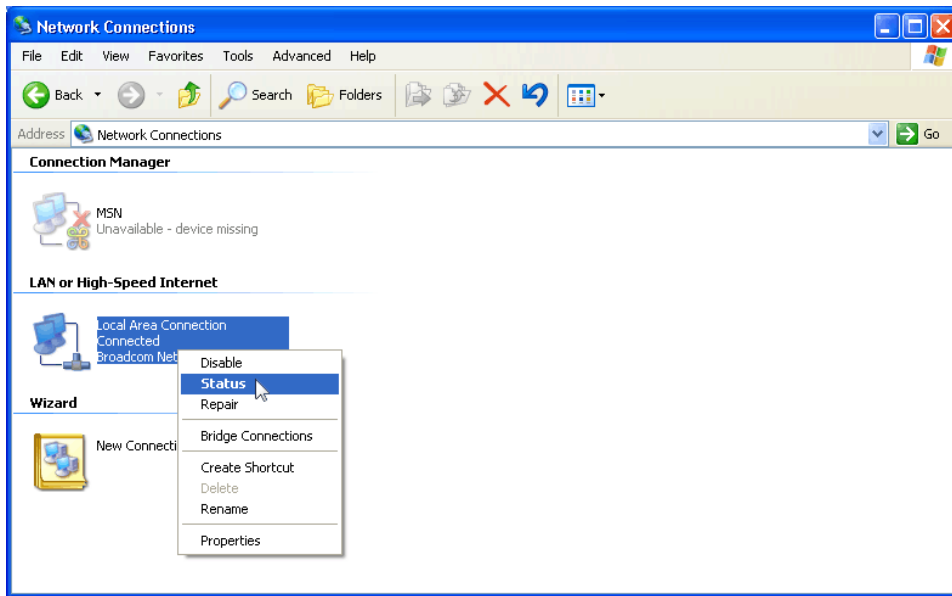

6. The **IP Address**, **Subnet Mask**, and **Default Gateway** should match the information in the illustration below.

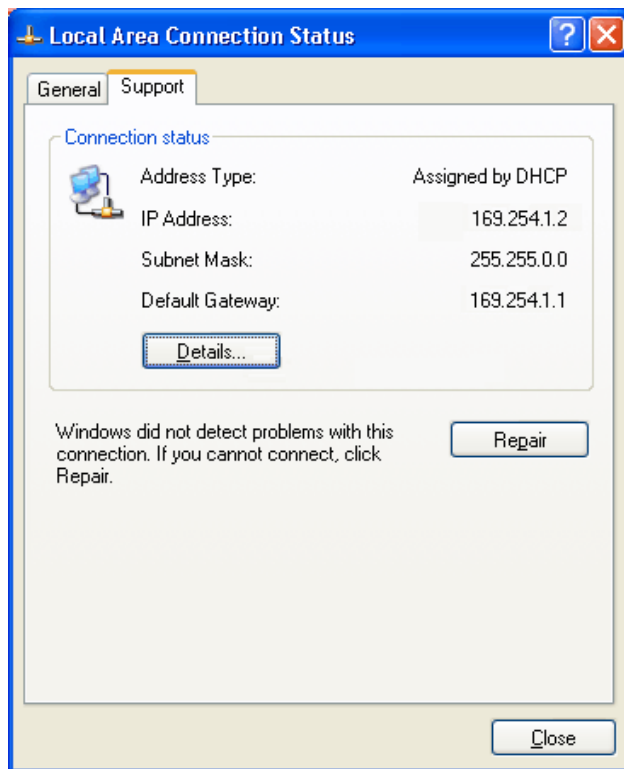

Troubleshooting Your IP Connection in Windows Vista/7

If the Connection Status Pane displays the message “Not Connected to Smart Siren Platinum Control Pad” after you have properly connected the system and tried to establish an IP connection between the control pad and your computer:

1. Set up and verify the IP connection between the control pad and your computer:
 - a) To power the control pad, turn the ignition key to the accessories position. When powered on, the control pad automatically provides a IP address to the computer.
 - b) In the **Start** menu, right-click **Network** and select **Properties**.

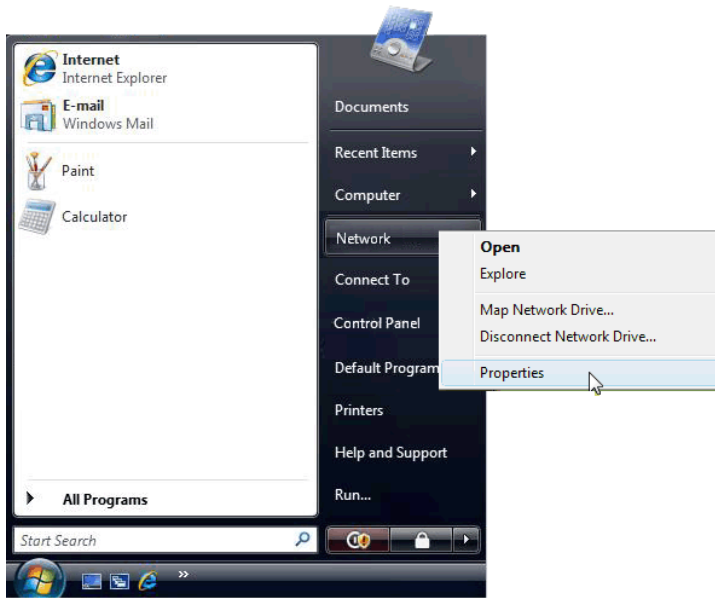

- c) In the **Network and Sharing Center**, click the link **Manage Network Connections**.

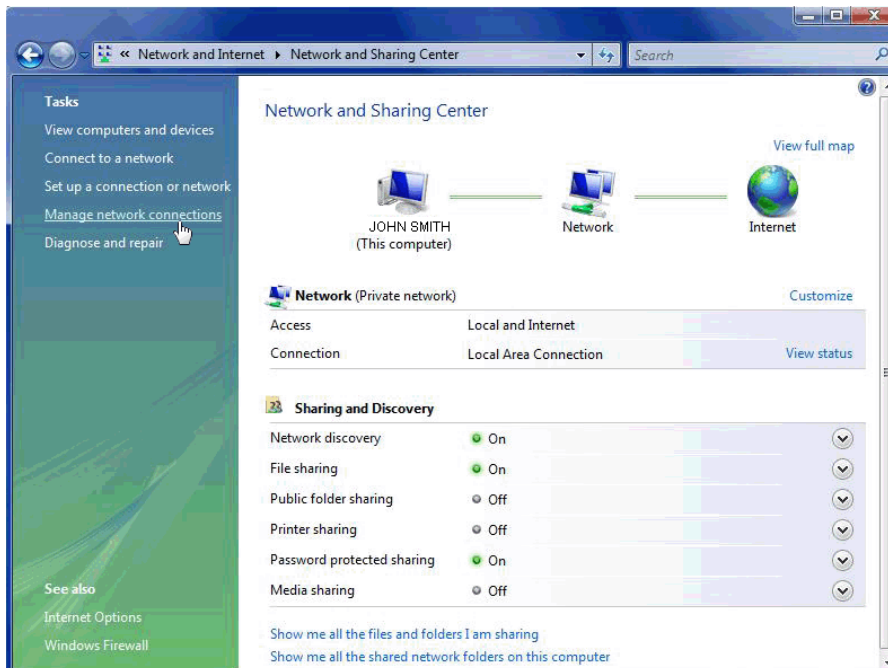

d) To check your **IPv6 Address**, **IPv6 Subnet Mask**, and **IPv6 Default Gateway**, right-click your **Local Area Connection** and select **Status**.

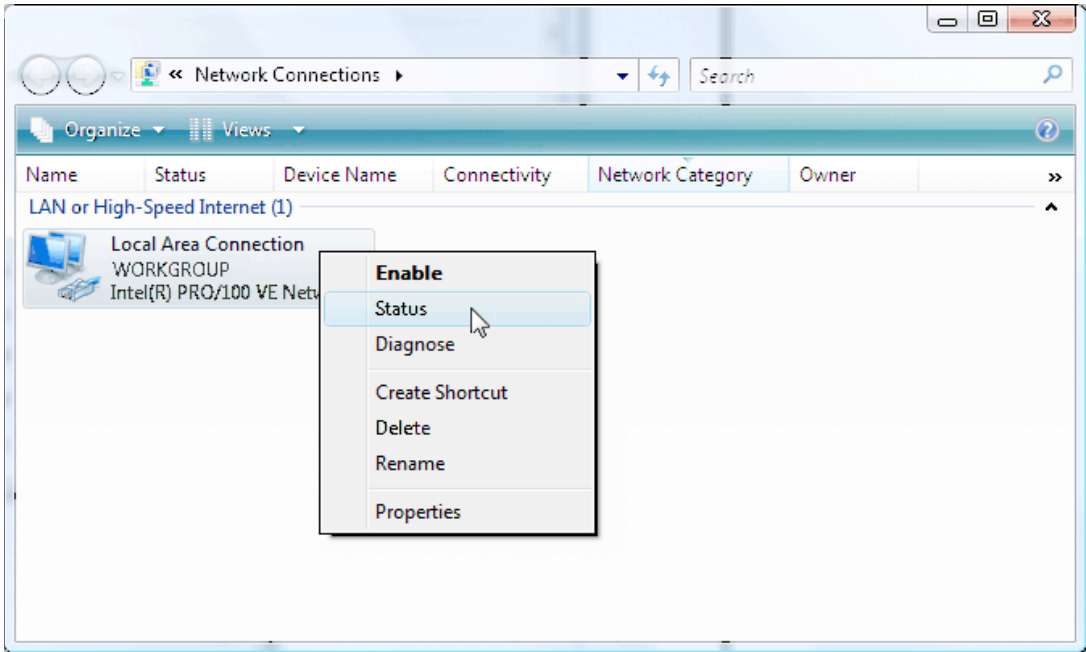

e) In the **Network Connection Status** window, click **Details**.

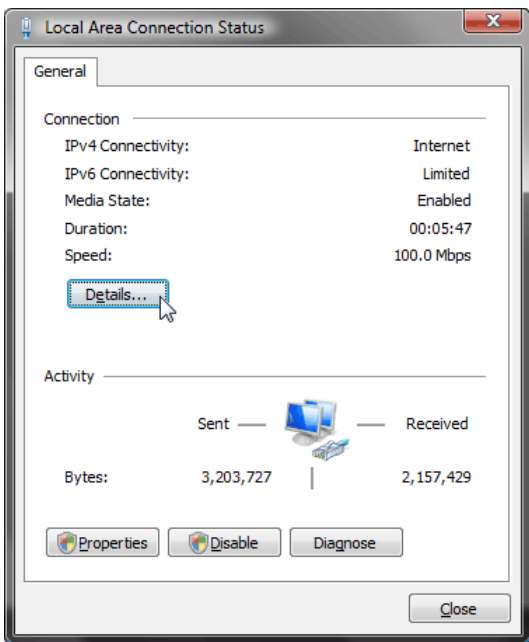

- f) In the **Network Connection Details** the **IPv6 Address**, **IPv6 Subnet Mask**, and **IPv6 Default Gateway** should match the information in the illustration below. Click **Close** to exit. If they do not match those in the illustration, see "Resetting Your IP Address in Windows Vista/7" in the next section.

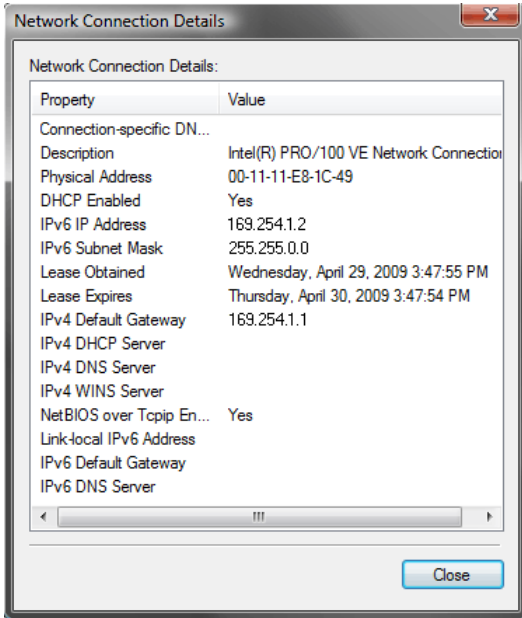

Resetting Your IP Address in Windows Vista/7

If the **IPv6 Address**, **IPv6 Subnet Mask**, and **IPv6 Default Gateway** do not match the illustration above, reset the network connection by disabling and enabling it.

- 1. In the **Start** menu, right-click **Network** and select **Properties**.

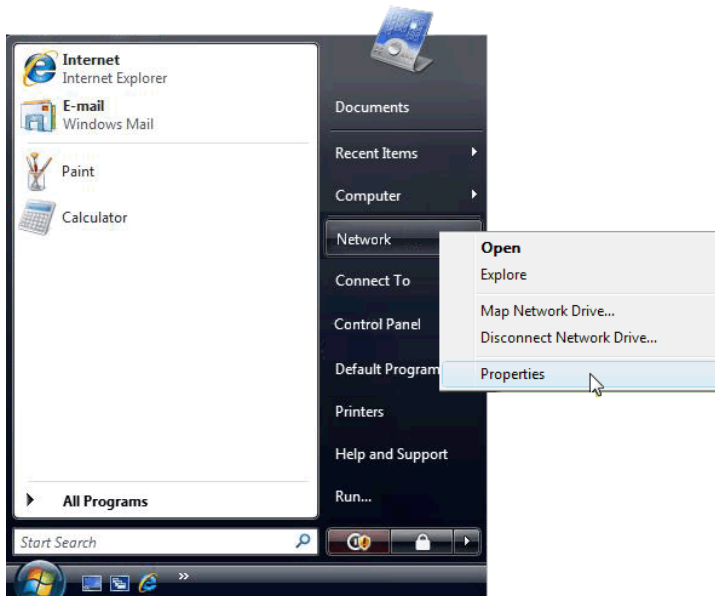

2. In the **Network and Sharing Center**, click the link **Manage Network Connections**.

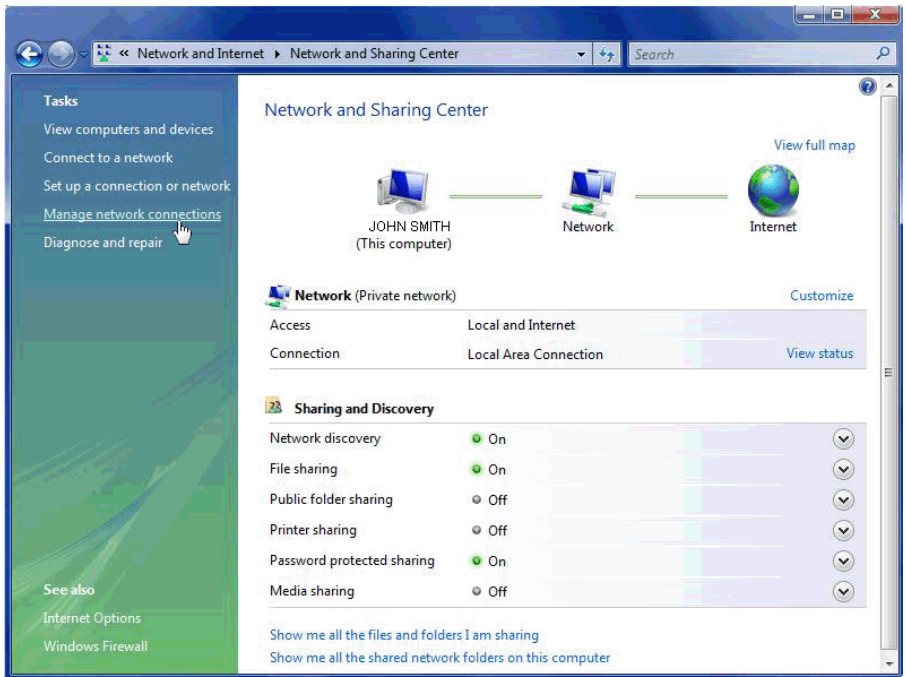

3. Select your **Local Area Connection** and click **Disable this network device**.

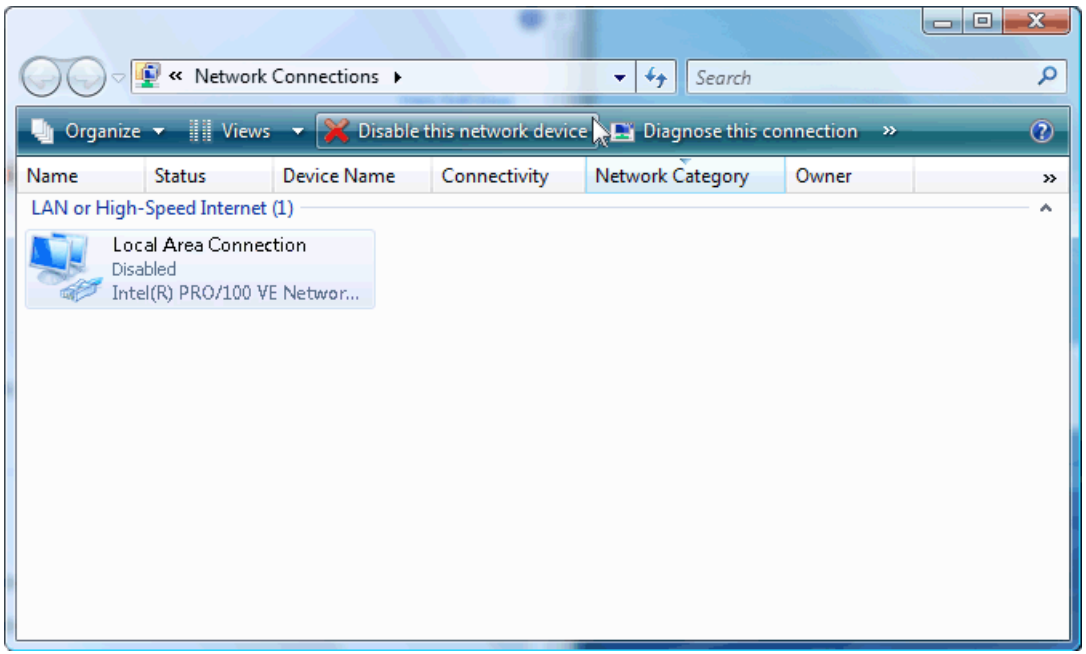

4. Wait for the connection to be disabled, then right-click **Local Area Connection** and click **Enable this network device**.

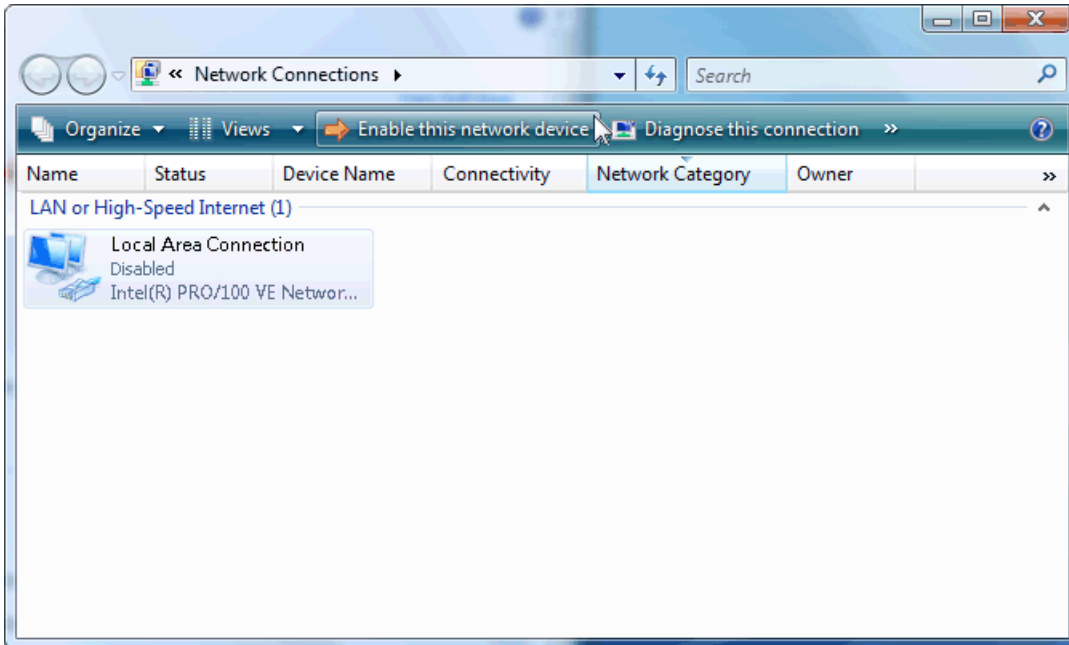

5. Wait for Windows Vista to reconnect to the network.

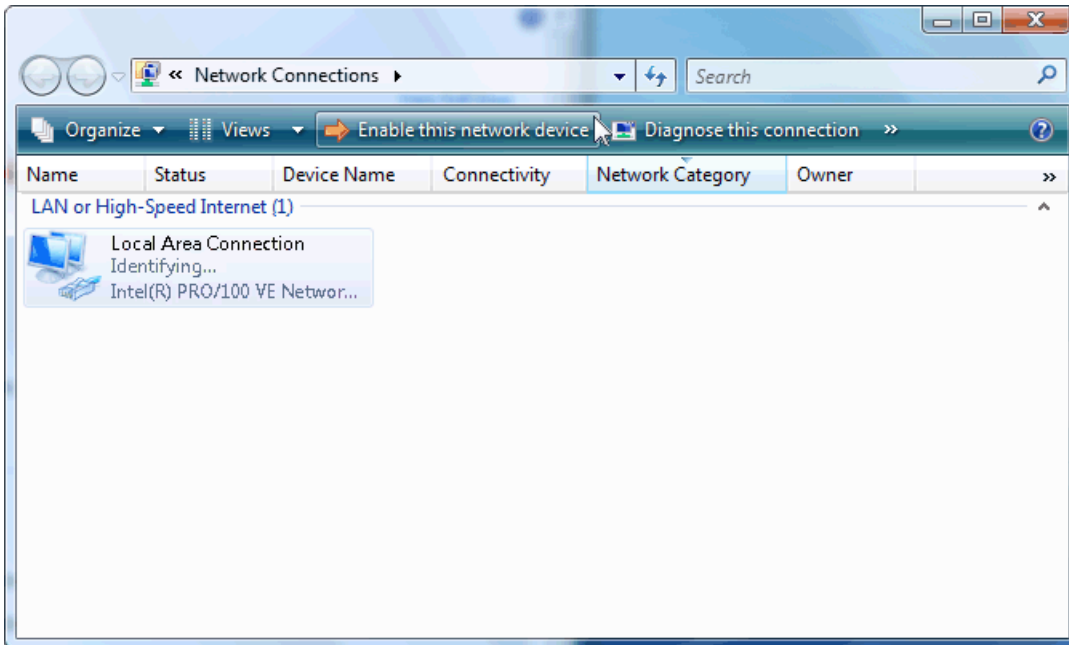

- To check your **IPv6 Address**, **IPv6 Subnet Mask**, and **IPv6 Default Gateway**, right-click **Local Area Connection** and select **Status**.

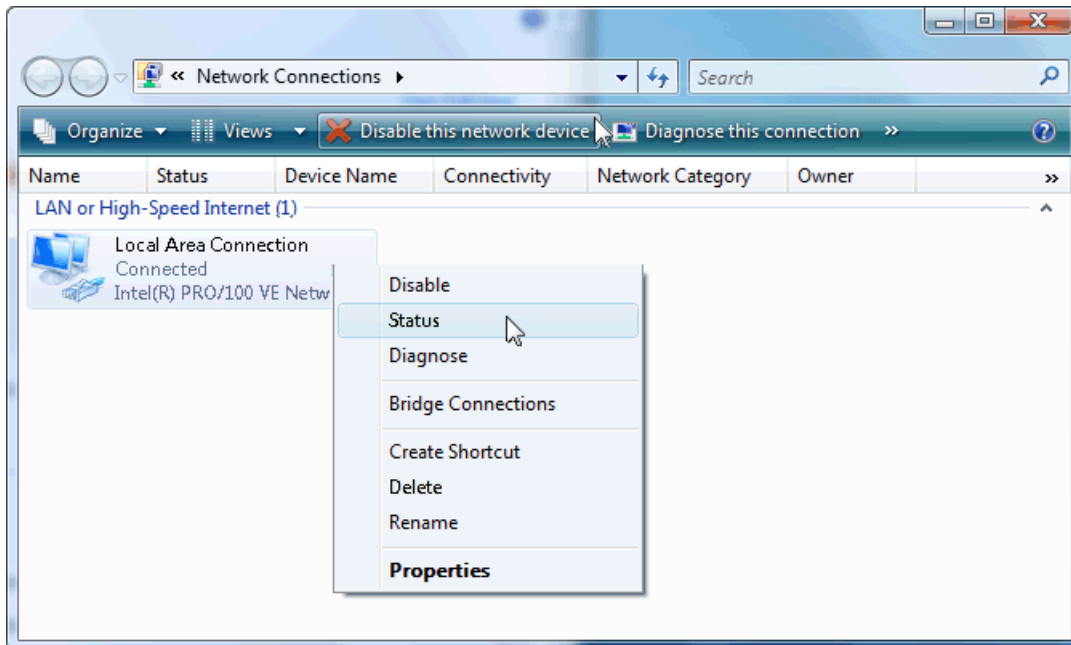

- In the **Network Connection Status** window, click **Details**.

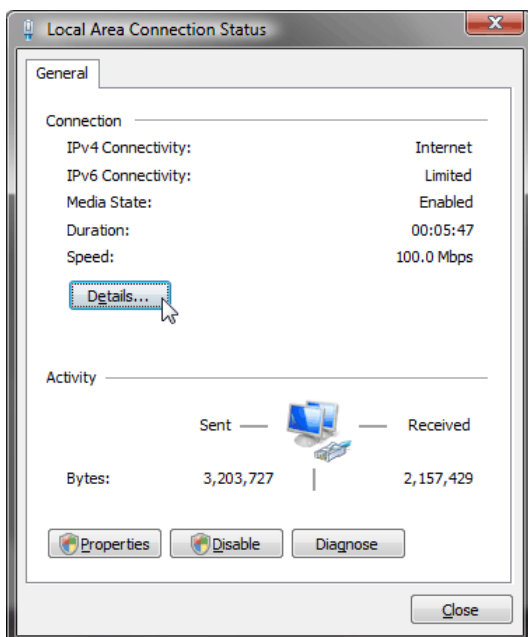

8. In the **Network Connection Details** the **IPv6 Address**, **IPv6 Subnet Mask**, and **IPv6 Default Gateway** should match the information in the illustration below.

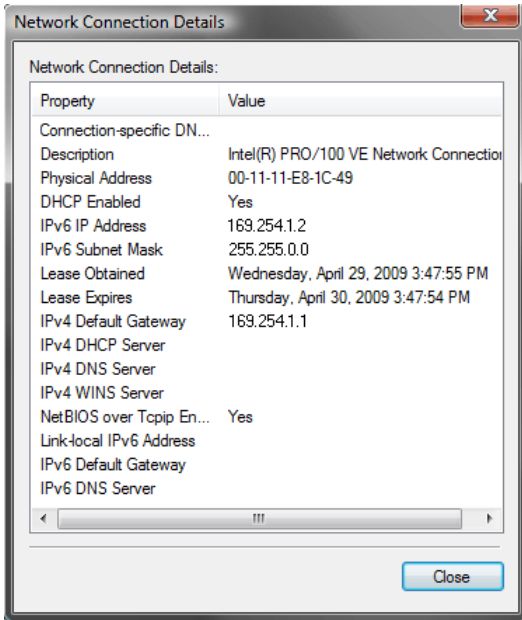

The Default Configuration

When you launch the SmartSiren Platinum Configuration Software, it loads a ready-to-use default configuration file. The illustration below shows the buttons and the default settings assigned to them. You can use the settings as they are or modify them.

<p>Signal Master Left, Right, Center Out Rear Lightbar 8-Head Discrete</p>		<p>Warn Step-Through Warning Patterns 1 to 4 Rear Lightbar 8-Head Discrete</p>						<p>Button 14 Button Control: Push On/Off Lightbar: Dimming</p>	<p>Button 15 Button Control: Push On/Off Rear Light Cutoff</p>
<p>Button 6 Button Control: Exclusive Siren: Standby</p>	<p>Button 7 Button Control: Exclusive Siren: Radio</p>	<p>Button 8 Button Control: Push On/Off Active Hi/Low 10 A Relay 9 Relay Function: Steady On Active Hi Open Off</p>	<p>Button 9 Button Control: Exclusive Siren: Wail</p>	<p>Button 10 Button Control: Exclusive Siren: Yelp</p>	<p>Button 11 Button Control: Exclusive Siren: Priority</p>	<p>Button 12 Button Control: Momentary Siren: Manual</p>	<p>Button 13 Button Control: Momentary Siren: Air Horn</p>		
<p>Slide Switch 1 Button Control: Momentary Lightbar Pattern 10 Front Light Cutoff Relay: Active Hi/Low 10 A Relay 1 Relay Function: Steady On Active Hi Open Off</p>	<p>Slide Switch 2 Button Control: Momentary Lightbar Pattern 17 Horn Ring Transfer Relay: Active Hi/Low 10 A Relays 1-3 Relay Function: Steady On Active Hi Open Off</p>	<p>Slide Switch 3 Button Control: Progressive Flash Take-down/Alley Lightbar Pattern 26 Siren Dependent Enabled Horn Ring Transfer Active Hi/Low 10 A Relays 1-5 Relay Function: Steady On Active High, Open Off</p>	<p>Button 1 Button Control: Push On/Off Lightbar: Left Alley Active Hi/Low 10 A Relay 6 Relay Function: Steady On Active High, Open Off</p>	<p>Button 2 Button Control: Push On/Off Lightbar: Takedowns Active Hi/Low 10 A Relay 7 Relay Function: Steady On Active High Open Off</p>	<p>Button 3 Button Control: Push On/Off Lightbar: Right Alley Active Hi/Low 10 A Relay 8 Steady On Active High Open Off</p>	<p>Button 4 Button Control: Timer: 8 Second Lightbar: Intersection Pattern 22</p>	<p>Button 5 Button Control: Security Timer: 8 Seconds Active Hi/Low 10 A Relay 10: Relay Function: Steady On Active High Open Off</p>		

<p>Input 1 Active Low Button Control: Momentary</p>	<p>Input 2 Active Low Button Control: Momentary</p>	<p>Input 3 Active High Button Control: Momentary</p>	<p>Input 4 Active High Button Control: Momentary</p>
--	--	---	---

<p>Horn Ring</p>

SignalMaster	Warn	SMARTSIREN® PLATINUM SERIES  BUTTON LAYOUT WORKSHEET					Button 14	Button 15
Button 6	Button 7	Button 8*	Button 9	Button 10	Button 11	Button 12	Button 13	
Slide Switch 1	Slide Switch 2	Slide Switch 3	Button 1	Button 2	Button 3	Button 4	Button 5	



2645 Federal Signal Drive, University Park, IL 60484-3167

Tel.: (800) 264-3578 • Fax: (800) 682-8022

www.fedsig.com

© 2011 Federal Signal Corporation